

## Heizungs- / Fernheizungsregler SDC Heating Controller / District Heating Controller SDC

### INSTALLATIONSANLEITUNG / INSTALLATION INSTRUCTIONS

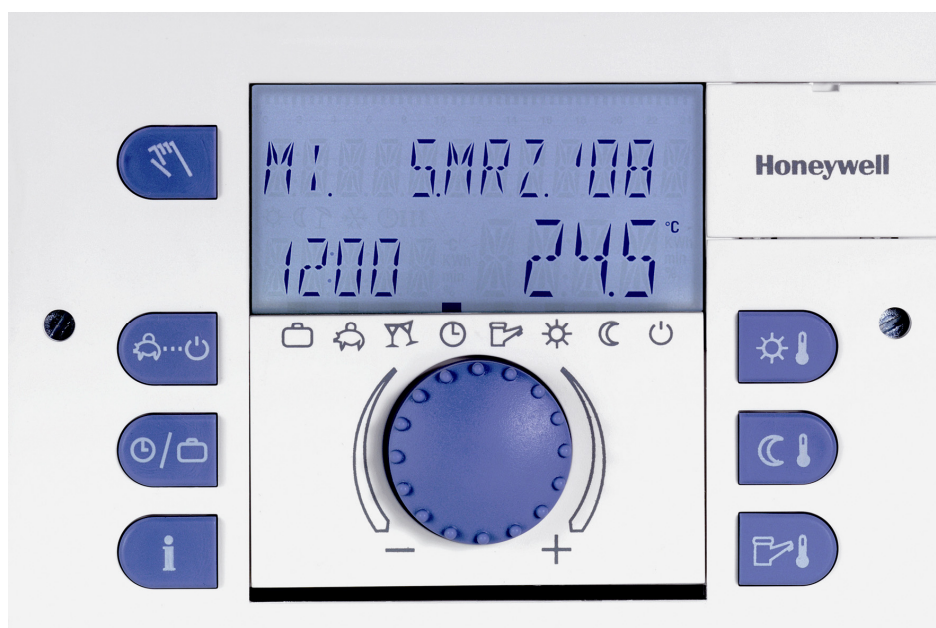

Deutsch 3

English 23



## Inhaltsverzeichnis

<b>1</b>	<b>Softwareversion</b> .....	<b>5</b>
<b>2</b>	<b>Sicherheitshinweise</b> .....	<b>5</b>
2.1	Bestimmungsgemäße Verwendung .....	5
2.2	Voraussetzungen für die Inbetriebnahme.....	5
2.2.1	Stromversorgung .....	6
2.2.2	Anschlussbedingungen .....	6
2.2.3	Leitungsquerschnitte .....	6
2.2.4	Maximale Kabellängen .....	6
2.2.5	Leitungsverlegung .....	7
2.2.6	Erdung und Nullung.....	7
2.3	Warmwassertemperatur größer 60 °C .....	7
2.4	Anschluss von Zubehörteilen .....	8
2.5	Wartung und Reinigung.....	8
<b>3</b>	<b>Montage</b> .....	<b>8</b>
<b>4</b>	<b>Anschlussbelegung</b> .....	<b>9</b>
4.1	Bei Wandsockel für Heizungs- / Fernheizungsanwendungen .....	11
4.2	Anschluss einer Sicherheitseinrichtung an Antrieb bei Fernheizungsreglern .....	13
<b>5</b>	<b>Auswahl von Parameter-Voreinstellungen für eine Hydraulik</b> .....	<b>14</b>
<b>6</b>	<b>Applikationen</b> .....	<b>14</b>
<b>7</b>	<b>Technische Daten</b> .....	<b>15</b>
7.1	Allgemein .....	15
7.2	Fühler-Widerstandswerte .....	16
7.2.1	NTC 20 .....	16
7.2.2	PT 1000.....	16
7.3	Fühler-Messbereiche.....	17
7.4	Digitaleingänge .....	17

---

<b>8</b>	<b>Anschluss von Raumgeräten.....</b>	<b>18</b>
8.1	Raumfühler RF 20.....	18
8.2	Wandmodul TF 22 / TFU 22.....	19
8.3	Wandmodul SDW 10 / SDW 30 .....	20

## 1 Softwareversion

Diese Dokumentation ist gültig für die Softwareversion **V 3.2** Ihres Regelgeräts. Die Softwareversion wird nach dem Einschalten für ca. 8 s angezeigt. Sollten Sie eine ältere Softwareversion benutzen, kontaktieren Sie bitte Ihren Heizungsfachmann.

## 2 Sicherheitshinweise

### 2.1 Bestimmungsgemäße Verwendung

Die Smile-Reglerfamilie SDC / DHC ist ausschließlich zur Regelung und Steuerung von Warmwasser-, Heizungs- und Fernheizungsanlagen (einschließlich Warmwasserbereitung) bestimmt, die eine max. Vorlauftemperatur von 120 °C nicht überschreiten.

### 2.2 Voraussetzungen für die Inbetriebnahme

#### **▲ ACHTUNG**

**Die Heizungsanlage muss fertig gestellt und mit Wasser gefüllt sein, damit die Pumpen nicht trocken laufen und der Heizkessel keinen Schaden erleidet.**

**Die Regeleinrichtung muss gemäß Montageanleitung installiert sein.**

**Alle elektrischen Anschlüsse (Spannungsversorgung, Brenner, Mischermotor, Pumpen, Fühlerverdrahtung etc.) müssen vom Fachmann nach den gültigen VDE-Vorschriften ausgeführt sein und den Schaltbildern entsprechen.**

**Ist eine Fußbodenheizung angeschlossen, muss bauseitig zusätzlich ein Begrenzungsthermostat in der Vorlaufleitung nach der Heizkreispumpe installiert werden, der bei zu hohen Vorlauftemperaturen die Pumpen ausschaltet.**

**Vor Inbetriebnahme des Reglers alle obigen Voraussetzungen vom Heizungsfachmann prüfen lassen.**

**HINWEIS** Die aktuelle Uhrzeit und das Datum sind bereits vom Werk eingestellt und über eine Batterie gesichert.

Die Schaltuhr arbeitet nach einem Grundprogramm und die Regelfunktionen sind für übliche Heizungsanlagen mit Niedertemperaturkessel voreingestellt.

### 2.2.1 Stromversorgung

Regler nicht vom Stromnetz trennen!

Die Batterie für die Sicherung aller individuellen Daten wird sonst unnötig beansprucht. Die Frostschutzfunktion des Reglers wird außer Betrieb gesetzt.

### 2.2.2 Anschlussbedingungen

Alle elektrischen Anschlussarbeiten nur von qualifiziertem Personal durchführen lassen!

### 2.2.3 Leitungsquerschnitte

**1,5 mm<sup>2</sup>** für alle 230 V führenden Leitungen (Netzanschluss, Brenner, Pumpen, Stellmotor).

**0,6 mm<sup>2</sup>** für Busleitungen (Empfohlene Ausführung J-Y(St)Y 2 x 0,6).

**0,5 mm<sup>2</sup>** für Fühler-, Wähler- und Analogsignalleitungen.

### 2.2.4 Maximale Kabellängen

#### **Fühler-, Wähler- und Analogeingänge**

Es werden max. 200 m Kabellänge empfohlen. Längere Verbindungsleitungen sind möglich, erhöhen aber die Gefahr von Störeinstrahlungen.

#### **Relaisausgänge**

Unbegrenzte Kabellänge.

### **Busverbindungen**

Max. Länge 100 m, vom ersten bis zum letzten Busteilnehmer (incl. Wandmodule).

### **2.2.5 Leitungsverlegung**

Leitungen für Fühler getrennt von den 230 V führenden Leitungen verlegen! Abzweigdosen in Fühlerleitung unbedingt vermeiden!

### **2.2.6 Erdung und Nullung**

Örtliche Vorschriften beim Anschluss der Geräte unbedingt beachten!

## **2.3 Warmwassertemperatur größer 60 °C**

### **▲ ACHTUNG**

**Beachten Sie, dass in folgenden Fällen an allen Warmwasserentnahmestellen (Küche, Bad, etc.) Verbrühungsgefahr besteht. Mischen Sie in diesen Fällen genügend kaltes Wasser dazu.**

#### **Anti-Legionellen-Automatik**

Bei aktivierter Anti-Legionellen-Automatik wird das Warmwasser automatisch an dem gewählten Tag und zur gewählten Zeit auf die Anti-Legionellen-Temperatur (werkseitig 65 °C) erhitzt, um etwaige Legionellen-Bakterien im Warmwasserspeicher abzutöten.

#### **Handbetrieb / Emissionsmessung**

In der Betriebsart Handbetrieb / Emissionsmessung kann das Warmwasser bis auf die max. mögliche Kesseltemperatur aufgeheizt werden, weil der Brenner und alle Pumpen eingeschaltet werden und der Mischer voll geöffnet wird. Es besteht hier akute Verbrühungsgefahr an allen angeschlossenen Warmwasser-Entnahmestellen! Mischen Sie genügend kaltes Wasser dazu oder schalten Sie die Warmwasserladepumpe aus (am Schalter an der Pumpe, falls vorhanden). Heizung und Warmwasser befinden sich im unregelmäßigen Dauerbetrieb. Diese Betriebsart wird speziell vom Schornsteinfeger zur Emissionsmessung verwendet oder bei einem Defekt des Reglers.

Die hohen Warmwassertemperaturen können jedoch vermieden werden, indem der Kesselthermostat auf eine max. Kesseltemperatur von ca. 60 °C eingestellt wird.

## 2.4 Anschluss von Zubehörteilen

### **WARNUNG**

**Laut VDE 0730 ist in der Spannungszuführung zur Regeleinrichtung eine Trennvorrichtung für jeden Netzpol vorzusehen. Beachten Sie die örtlichen Vorschriften bezüglich Erdung und Nullung.**

**Sobald Netzspannung an den Klemmen 21, 22, 2, 6, 12 und 18 angelegt ist, können die Stiftleisten X3 und X4 auch Netzspannung führen.**

**Wenn Heizkreis- und Warmwasserladepumpe keine Ein- / Ausschalter besitzen, aber trotzdem eine manuelle Ein- / Ausschaltmöglichkeit gewünscht ist, müssen bauseitig die entsprechenden Schalter installiert werden. Alle Zubehörteile (Fühler, Wähler etc.) sind nach dem jeweiligen Schaltbild anzuschließen.**

## 2.5 Wartung und Reinigung

Der Regler ist wartungsfrei. Das Gerät kann außen mit einem feuchten (nicht nassen) Tuch gereinigt werden.

## 3 Montage

Siehe 9 Montage / Installation, S. 42.



## 4 Anschlussbelegung

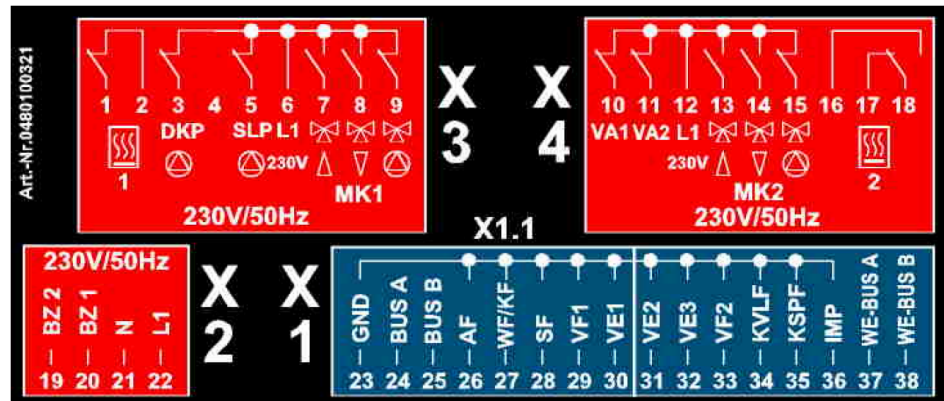

### Netzseitiger Anschluss

Nr.	Anschluss
1	Ausgang Relais Wärmeerzeuger (T2), Stufe 1; bei Fernheizungsreglern Fernheizventil ZU
2	Eingang Relais Wärmeerzeuger (T1), Stufe 1; bei Fernheizungsreglern L1
3	Direktheizkreispumpe
4	Nicht belegt
5	Warmwasserladepumpe
6	L1 / 230 V
7	Mischermotor 1 AUF
8	Mischermotor 1 ZU
9	Mischheizkreispumpe 1
10	Variabler Ausgang 1
11	Variabler Ausgang 2
12	L1 / 230 V
13	Mischermotor 2 AUF
14	Mischermotor 2 ZU
15	Mischheizkreispumpe 2
16	Stufe 2 (T7); bei Fernheizungsreglern Fernheizventil AUF
17	Ausgang Relais Wärmeerzeuger (T8), Stufe 2
18	Eingang Relais Wärmeerzeuger (T6), Stufe 2; bei Fernheizungsreglern L1
19	Betriebsstundenzähler Brenner, Stufe 2
20	Betriebsstundenzähler Brenner, Stufe 1

Nr.	Anschluss
21	N / 230 V
22	L 1 / 230 V Netzanschluss

**Fühler- / Datenbus-  
Anschluss**

Nr.	Anschluss
23	Gemeinsame Fühlermasse
24	Busseitig A
25	Busseitig B
26	Außenfühler
27	Wärmeerzeugerfühler / Kesselfühler
28	Warmwasserfühler
29	Vorlauffühler Mischheizkreis 1
30	Variabler Eingang 1
31	Variabler Eingang 2
32	Variabler Eingang 3, VFB*
33	Vorlauffühler Mischheizkreis 2
34	Kollektorvorlauffühler (Solaranwendung, PT 1000)
35	Kollektorrücklauffühler (Solaranwendung)
36	Impulseingang
37	OpenTherm A
38	OpenTherm B

\* bei Fernheizungsreglern

#### 4.1 Bei Wandsocket für Heizungs- / Fernheizungsanwendungen

X5		X6		X7		X8		X9		X10	
1	Bus B	1	Bus A	1	T1	1	T2/V1 ▼	1	N	1	PE
2	GND	2	AF	2		2	DKP	2	N	2	PE
3	GND	3	WF/KF	3		3	SLP	3	N	3	PE
4	GND	4	SF	4		4	MK1 ▲	4	N	4	PE
5	GND	5	VF1	5	L1	5	MK1 ▼	5	N	5	PE
6	GND	6	VE1	6		6	P1	6	N	6	PE
7	GND	7	VE2	7		7	VA1	7	N	7	PE
8	GND	8	VE3	8		8	VA2	8	N	8	PE
9	GND	9	VF 2	9	T6	9	MK2 ▲	9	N	9	PE
10	GND	10	KVLF	10	T8	10	MK2 ▼	10	N	10	PE
11	GND	11	KSPF	11	T7/V1 ▲	11	P2	11	N	11	PE
12	GND	12	IMP					12	N	12	PE
								13	N	13	PE

Brücke bei Fernheizungsreglern

▲ AUF

▼ ZU

Kurzbezeichnung	Bedeutung
T2B A, Bus A	Datenbus Anschluss A
T2B B, Bus B	Datenbus Anschluss B
AF	Außenfühler, GND-Anschluss auf X5
WF / KF	Wärmeerzeugerfühler, GND-Anschluss auf X5
SF	Speicherfühler, GND-Anschluss auf X5
VF1	Vorlauffühler Mischheizkreis 1, GND-Anschluss auf X5
VE1	Variabler Eingang 1, GND-Anschluss auf X5
VE2	Variabler Eingang 2, GND-Anschluss auf X5
VE3	Variabler Eingang 3, VFB*, GND-Anschluss auf X5
VF2	Vorlauffühler Mischheizkreis 2, GND-Anschluss auf X5
KVLF	Kollektorvorlauffühler, GND-Anschluss auf X5
KSPF	Kollektorspeicher- / Pufferfühler, GND-Anschluss auf X5
IMP	Impulseingang, GND-Anschluss auf X5
T1	Brenner Anschluss (T1), Stufe 1; bei Fernheizungsreglern L1

<b>Kurzbezeichnung</b>	<b>Bedeutung</b>
T2	Brenner Anschluss (T2), Stufe 1; bei Fernheizungsreglern Fernheizventil V1 ZU, N auf X9, PE auf X10
T6	Brenner Anschluss (T6), Stufe 2; bei Fernheizungsreglern L1
T7	Brenner Anschluss (T7), Stufe 2; bei Fernheizungsreglern Fernheizventil V1 AUF
T8	Brenner Anschluss (T8), Stufe 2
DKP	Direktheizkreispumpe, Anschlüsse N und PE auf X9 / X10
SLP	Speicherladepumpe, Anschlüsse N und PE auf X9 / X10
MKP1	Pumpe Mischheizkreis 1, Anschlüsse N und PE auf X9 / X10
MK1 AUF	Mischer auf Mischheizkreis 1, Anschlüsse N und PE auf X9 / X10
MK1 ZU	Mischer zu Mischheizkreis 1, Anschlüsse N und PE auf X9 / X10
VA1	Variabler Ausgang 1, Anschlüsse N und PE auf X9 / X10
VA2	Variabler Ausgang 2, Anschlüsse N und PE auf X9 / X10
MKP 2	Pumpe Mischheizkreis 2, Anschlüsse N und PE auf X9 / X10
MK2 AUF	Mischer auf Mischheizkreis 2, Anschlüsse N und PE auf X9 / X10
MK2 ZU	Mischer zu Mischheizkreis 2, Anschlüsse N und PE auf X9 / X10
VFB	Vorlauf temperatur-Begrenzungsfühler
GND	Masseklemmen gebrückt für Fühlereingänge
N	Nullleiter gebrückt für angeschlossene Pumpen / Mischer
L1	230 V Netzanschluss

Kurzbezeichnung	Bedeutung
PE	PE-Schutzleiter gebrückt für angeschlossene Pumpen / Mischer

\* bei Fernheizungsreglern

#### 4.2 Anschluss einer Sicherheitseinrichtung an Antrieb bei Fernheizungsreglern

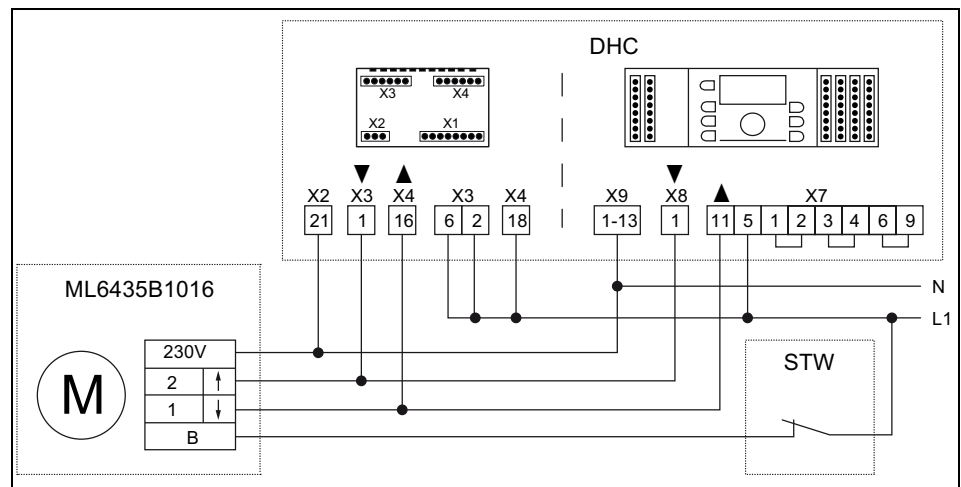

## 5 Auswahl von Parameter-Voreinstellungen für eine Hydraulik

Jede Reglertype deckt im Auslieferungszustand mehrere Hydrauliken ab. Jede Hydraulik kann durch Änderung und / oder Hinzufügung von Parametern geändert bzw. erweitert werden.

Eine Hydraulik wird mit dem Parameter 01 im Menü "Hydraulik" gewählt. Die entsprechenden Ein- und Ausgänge werden gemäß Hydraulikschema automatisch zugeordnet.

Diese Funktion vereinfacht die Einstellung einer dokumentierten Hydraulik erheblich.

Weitere Anwendungen können durch Einstellen der individuellen Parameter abgedeckt werden. Für die Fälle, wo dies nötig ist, sind in dieser Montageanleitung die Parameter mit angegeben. Die Beschreibung, wie Sie in die Parametereinstellung gelangen, finden Sie in der Parameterliste.

### Bedienung

Bedien- hinweis	Menü	Parameter	Schema eingeben, z. B.
Hydraulik- vorauswahl	"Hydraulik"	01	0201

## 6 Applikationen

Siehe Kapitel 10 Heizungs-Applikationen / Heating applications S. 46 und Kapitel 11 Fernheizungs-Applikationen / District heating applications S. 72.

## 7 Technische Daten

### 7.1 Allgemein

<b>Netzanschlussspannung</b>	230 V +6 % / -10 %
<b>Nennfrequenz</b>	50 ... 60 Hz
<b>Leistungsaufnahme</b>	max. 5,8 VA
<b>Vorsicherung</b>	max. 6,3 A träge
<b>Kontaktbelastung der Ausgangsrelais</b>	2 (2) A
<b>Busschnittstelle</b>	zum Anschluss externer Geräte (Wandgerät, PC, Modem oder Gateway)
<b>Max. Buslänge</b>	50 m
<b>Stromversorgung über Bus</b>	12 V / 150 mA
<b>Umgebungstemperatur</b>	0 ... +50 °C
<b>Lagertemperatur</b>	-25 ... +60 °C
<b>Schutzart</b>	IP 30
<b>Schutzklasse nach EN 60730</b>	II
<b>Schutzklasse nach EN 60529</b>	III
<b>Funkschutz</b>	EN 55014 (1993)
<b>Störfestigkeit</b>	EN 55104 (1995)
<b>EG-Konformität</b>	89/336/EWG
<b>Gehäuseabmessungen</b>	144 x 96 x 75 mm (B x H x T)
<b>Gehäusematerial</b>	ABS mit Antistatikum
<b>Anschlusstechnik</b>	Steckbare Schraubklemmverbindungen

## 7.2 Fühler-Widerstandswerte

### 7.2.1 NTC 20

Für Außenfühler (AF), Wärmeerzeugerfühler (WF / KF), Speicherfühler (SF), Vorlauffühler Mischheizkreis 1 (VF1), Vorlauffühler Mischheizkreis 2 (VF2), Variablen Eingang 1 (VE1) (Einstellung nicht Abgasfühler), Variablen Eingang 2 (VE2), Variablen Eingang 3 (VE3), Kollektorspeicher- / Pufferfühler (KSPF).

°C	kΩ	°C	kΩ	°C	kΩ	°C	kΩ
-20	220,6	0	70,20	20	25,34	70	3,100
-18	195,4	2	63,04	25	20,00	75	2,587
-16	173,5	4	56,69	30	15,88	80	2,168
-14	154,2	6	51,05	35	12,69	85	1,824
-12	137,3	8	46,03	40	10,21	90	1,542
-10	122,4	10	41,56	45	8,258	95	1,308
-8	109,2	12	37,55	50	6,718	100	1,114
-6	97,56	14	33,97	55	5,495	–	–
-4	87,30	16	30,77	60	4,518	–	–
-2	78,23	18	27,90	65	3,734	–	–

### 7.2.2 PT 1000

Für Variablen Eingang 1 (VE 1) (Einstellung Abgasfühler), Kollektorvorlauffühler (KVLf).

°C	Ω	°C	Ω	°C	Ω	°C	Ω
0	1000,00	80	1308,93	140	1535,75	280	2048,76
10	1039,02	85	1327,99	150	1573,15	300	2120,19
20	1077,93	90	1347,02	160	1610,43	320	2191,15
25	1093,46	95	1366,03	170	1647,60	340	2261,66
30	1116,72	100	1385,00	180	1684,65	360	2331,69
40	1155,39	105	1403,95	190	1721,58	380	2401,27
50	1193,95	110	1422,86	200	1758,40	400	2470,38
60	1232,39	115	1441,75	220	1831,68	450	2641,12
70	1270,72	120	1460,61	240	1904,51	500	2811,00
75	1289,84	130	1498,24	260	1976,86	–	–



### 7.3 Fühler-Messbereiche

Bezeichnung	Kurzbezeichnung	Fühlertyp	Messbereich
Außenfühler	AF	NTC 20	-50 °C ... 90 °C
Wärmeerzeugerfühler	KF	NTC 20	-50 °C ... 120 °C
Vorlauffühler 1	VF1	NTC 20	-50 °C ... 120 °C
Vorlauffühler 2	VF2	NTC 20	-50 °C ... 120 °C
Speicherfühler	SF	NTC 20	-50 °C ... 120 °C
Kollektorvorlauffühler	KVLF	PT 1000	-50 °C ... 210 °C
Kollektorspeicher- / Pufferfühler	KSPF	NTC 20	-50 °C ... 120 °C
Variabler Eingang VE1*	VE1	NTC 20 PT 1000	-50 °C ... 120 °C -50 °C ... 500 °C
Variabler Eingang VE2	VE2	NTC 20	-50 °C ... 120 °C
Variabler Eingang VE3	VE3	NTC 20	-50 °C ... 120 °C

\* Je nach Auswahl der zugeordneten Funktion.  
PT 1000 z. B. für Abgasfühleranschluss.

### 7.4 Digitaleingänge

Bezeichnung	Kurzbezeichnung	Eingangstyp	Messbereich
Impulszähler	Imp	Kleinspannung	≤ 10 Hz
Betriebsstundenzähler Brennerstufe 1	BZ1	230 V	AUS, EIN
Betriebsstundenzähler Brennerstufe 2	BZ2	230 V	AUS, EIN

## 8 Anschluss von Raumgeräten

Für die Smile-Regler gibt es verschiedene Varianten von Raumgeräten (Wandmodulen).

### 8.1 Raumfühler RF 20

#### Konfiguration

Die Konfiguration und Zuordnung erfolgt über Parameter 08, 09 oder 10 im Menü "Hydraulik".

Der elektrische Anschluss erfolgt entsprechend der Zuordnung an Variablen Eingang 1 (VE1) ... Variablen Eingang 3 (VE3) (Wandsocket).

**Beispiel:** Zuordnung Raumfühler an VE1

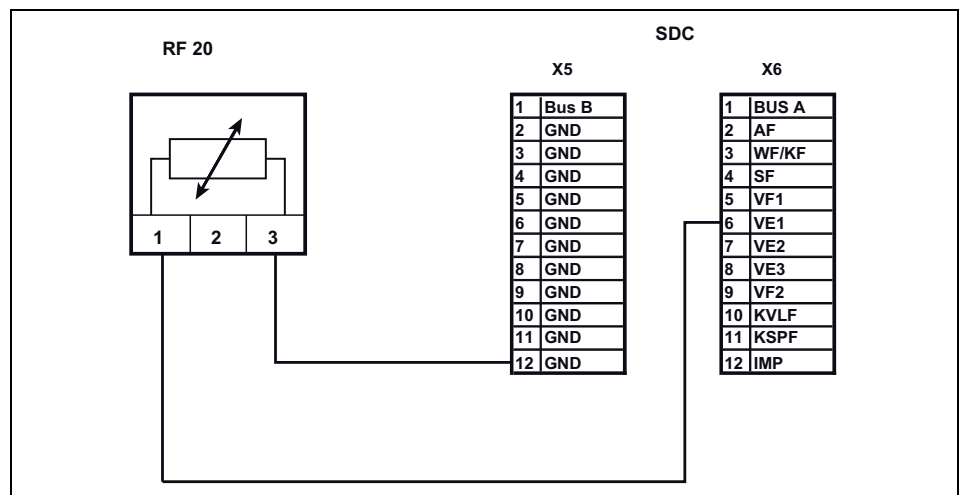

1 IST-Wert

3 GND

## 8.2 Wandmodul TF 22 / TFU 22

### Konfiguration

Die Konfiguration und Zuordnung erfolgt über Parameter 08, 09 oder 10 im Menü "Hydraulik" (Zuordnung variabler Eingang).

Es muss für das Signal "Raumtemperatur" und "Sollwert" jeweils ein variabler Eingang zugeordnet werden.

Der Parameter-Einstellwert für Raumfühler im Menü "Hydraulik" ist 30 (bei Direktkreis), 31 (bei Mischkreis 1) oder 32 (bei Mischkreis 2).

Der Parameter-Einstellwert für das Signal "Sollwertverschiebung" und "Betriebsart" im Menü "Hydraulik" ist 50 (bei Direktkreis), 51 (bei Mischkreis 1) oder 52 (bei Mischkreis 2)

Der elektrische Anschluss erfolgt entsprechend der Zuordnung an Variablen Eingang 1 (VE1) ... Variablen Eingang 3 (VE3) (Wandsockel).

**Beispiel:** Zuordnung TF 22 an Mischkreis 1 (Raumfühler VE1 und Sollwert / Betriebsart VE2)

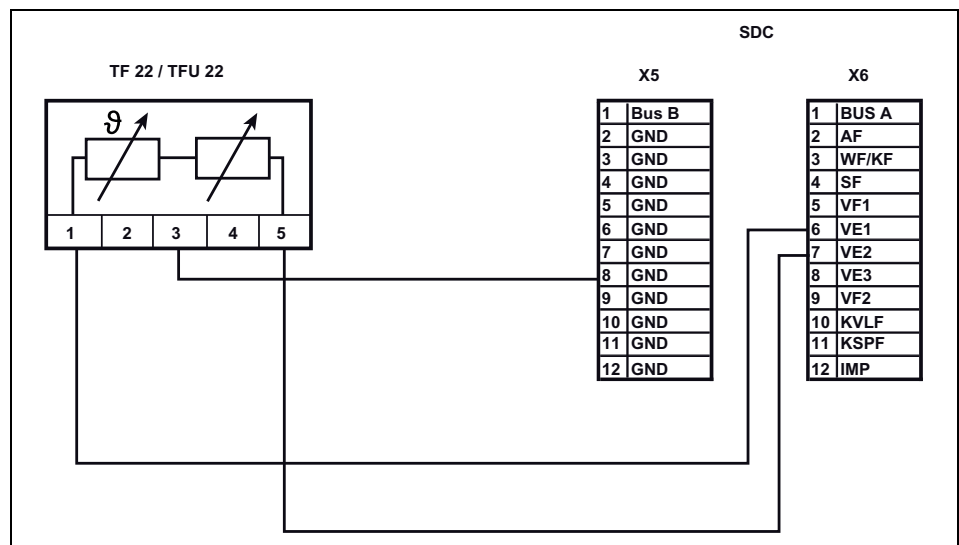

- 1 IST-Wert
- 3 GND
- 5 Sollwert/Betriebsart

### 8.3 Wandmodul SDW 10 / SDW 30

#### Konfiguration

Die Funktion des Wandmoduls SDW 10 oder SDW 30 muss mittels Parameter 03 des Heiz- oder Mischkreises am Regelgerät ausgewählt werden. Zusätzlich muss am Wandmodul eine Busadresse eingestellt werden.

Die Zuordnung erfolgt nach folgendem Schema:

Regler mit Busadresse 10 (Standardeinstellung) kommunizieren mit Wandmodulen mit Busadresse 1 (für Direktheizkreis), 2 (für Mischkreis 1) oder 3 (für Mischkreis 2).

#### Zuweisung der Busadresse

SDW 10 Busadresse	Zentralregler		Heizkreis
	Nr.	Busadresse	
1	1	10	Direktheizkreis
2	1	10	Mischerheizkreis 1
3	1	10	Mischerheizkreis 2
4	2	20	Direktheizkreis
5	2	20	Mischerheizkreis 1
6	2	20	Mischerheizkreis 2
7	3	30	Direktheizkreis
8	3	30	Mischerheizkreis 1
9	3	30	Mischerheizkreis 2
A	4	40	Direktheizkreis
B	4	40	Mischerheizkreis 1
C	4	40	Mischerheizkreis 2
D	5	50	Direktheizkreis
E	5	50	Mischerheizkreis 1
F	5	50	Mischerheizkreis 2
0	undefiniert		undefiniert

Beim Wandmodul SDW 30 können die Zugriffsrechte über die Parameter 02 ... 03 im Menü "Datenbus" eingestellt werden.

Der elektrische Anschluss der Wandmodule SDW 10 und SDW 30 erfolgt über die Busklemmen A und B:

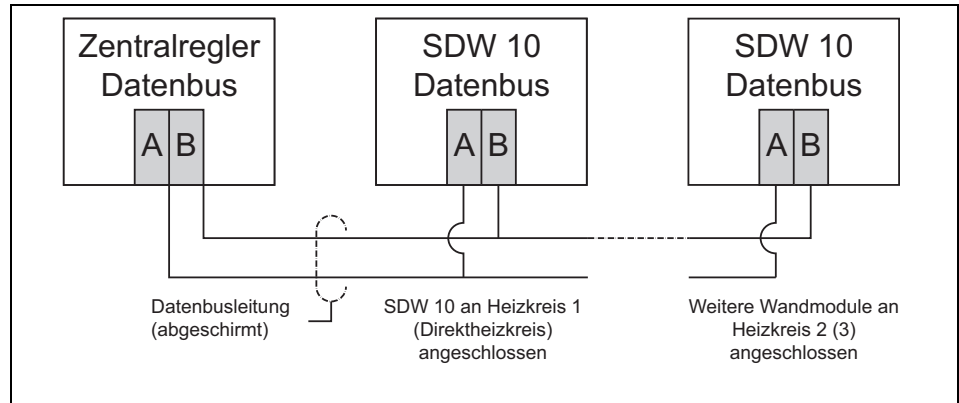



## Contents

<b>1</b>	<b>Software version .....</b>	<b>25</b>
<b>2</b>	<b>Safety instructions.....</b>	<b>25</b>
2.1	Intended use .....	25
2.2	Requirements for start-up.....	25
2.2.1	Power supply .....	26
2.2.2	Connection conditions .....	26
2.2.3	Cable cross-sections .....	26
2.2.4	Maximum cable lengths.....	26
2.2.5	Cable installation .....	26
2.2.6	Grounding and zeroing.....	27
2.3	Hot-water temperature greater than 60 °C .....	27
2.4	Connection of accessory parts .....	28
2.5	Maintenance and cleaning .....	28
<b>3</b>	<b>Installation.....</b>	<b>28</b>
<b>4</b>	<b>Connection assignment .....</b>	<b>29</b>
4.1	With wall base for heating / district heating applications .....	31
4.2	Connection of a safety device to the drive at district heating controllers .....	33
<b>5</b>	<b>Selection of parameter presettings for a hydraulic unit.....</b>	<b>34</b>
<b>6</b>	<b>Applications .....</b>	<b>34</b>
<b>7</b>	<b>Technical data.....</b>	<b>35</b>
7.1	General .....	35
7.2	Sensor resistance values .....	36
7.2.1	NTC 20 .....	36
7.2.2	PT 1000.....	36
7.3	Sensor measurement ranges .....	37
7.4	Digital inputs.....	37

---

<b>8</b>	<b>Connection of Room Devices .....</b>	<b>38</b>
8.1	Room Sensor RF20.....	38
8.2	Wall Module TF 22 / TFU 22 .....	39
8.3	Wall Module SDW 10 / SDW 30 .....	40



## 1 Software version

This documentation is valid for software version **V 3.2** of your control device. The software version is displayed after switch-on for approx. 8 s. If you are using an older software version, please contact your heating technician.

## 2 Safety instructions

### 2.1 Intended use

The SDC / DHC Smile family of controllers was designed for the sole purpose of regulating and controlling hot-water, heating and district heating systems (including hot-water production) that do not exceed a maximum flow temperature of 120 °C.

### 2.2 Requirements for start-up

#### **▲ ATTENTION**

**The heating system must be complete and filled with water so that the pumps do not run dry and the heating boiler is not damaged.**

**The control equipment must be installed in accordance with the installation instructions.**

**All electrical connections (voltage supply, burner, mixer motor, pumps, sensor wiring etc.) must be carried out by the technician in accordance with the applicable VDE regulations and correspond with the circuit diagrams.**

**If floor heating is connected, a limiting thermostat must also be installed in the flow line after the heating circuit pump. This switches off the pumps at excessive flow temperatures.**

**Before starting up the controller, have the heating technician check all requirements listed above.**

**NOTE** The current time and date are already set at the factory and are backed up by a battery.

The time switch functions based on a basic program and the control functions are preset for common heating systems with low-temperature boilers.

### 2.2.1 Power supply

Do not disconnect the controller from the mains supply!

The battery for saving all individualised data is otherwise unnecessarily strained. The frost-protection function of the controller is deactivated.

### 2.2.2 Connection conditions

All electrical connection work may only be carried out by qualified personnel!

### 2.2.3 Cable cross-sections

**1.5 mm<sup>2</sup>** for all cables carrying 230 V (power supply, burner, pumps, actuator).

**0.6 mm<sup>2</sup>** for bus cables (recommended type J-Y(St)Y 2 x 0.6).

**0.5 mm<sup>2</sup>** for sensors, selectors and analog signal cables.

### 2.2.4 Maximum cable lengths

#### Sensor, selector and analog inputs

We recommend using cables no longer than 200 m. Longer connection lines could be used, but increase the risk of interference.

#### Relay outputs

Unlimited cable length.

#### Bus connections

Max. length of 100 m from the first bus subscriber to the last one (incl. wall modules).

### 2.2.5 Cable installation

Install cables for sensors apart from the cables carrying 230 V!  
Branch boxes in the sensor cable must be avoided!

### 2.2.6 Grounding and zeroing

Local regulations on the connection of equipment must be observed!

### 2.3 Hot-water temperature greater than 60 °C

#### ATTENTION

**Note that there is a danger of scalding at all hot-water draw-off points (kitchen, bathroom etc.) in the following cases. Add sufficient cold water in these cases.**

#### **Automatic anti-legionella mechanism**

When the automatic anti-legionella mechanism is activated, the hot water is automatically heated to the anti-legionella temperature (65 °C at the factory) on the selected day and at the selected time to kill any legionella bacteria found in the hot-water tank.

#### **Manual mode / Emission measurement**

In the manual mode / emission measurement operating mode, the hot water is heated up to the highest possible boiler temperature, as the burner and all pumps are switched on and the mixer is opened fully. There is an acute danger of scalding at all connected hot-water draw-off points! Add sufficient cold water or switch off the hot-water charging pump (at the switch of the pump, if present). Heating and hot water are in unregulated continuous operation. This operating mode is for special use by the chimney sweep for emission measurement or if the controller is defective. The high hot-water temperatures can be prevented, however, by setting the boiler thermostat to a max. boiler temperature of approx. 60 °C.

## 2.4 Connection of accessory parts

### **WARNING**

According to VDE 0730, a separator for each mains terminal is to be provided in the voltage supply to the control equipment. Observe the local regulations regarding grounding and zeroing.

As soon as the mains voltage is applied to terminals 21, 22, 2, 6, 12 and 18, headers X3 and X4 can also carry mains voltage.

If the heating circuit and hot-water charging pumps do not have an On / Off switch, but manual switch-on and switch-off capability is still desired, the appropriate switches must be installed by the customer. All accessory parts (sensors, selectors etc.) are to be connected to the respective circuit diagram.

## 2.5 Maintenance and cleaning

The controller is maintenance-free. The device can be cleaned externally with a moist (not wet) cloth.

## 3 Installation

See 9 Montage / Installation, pg. 42.

### 4 Connection assignment

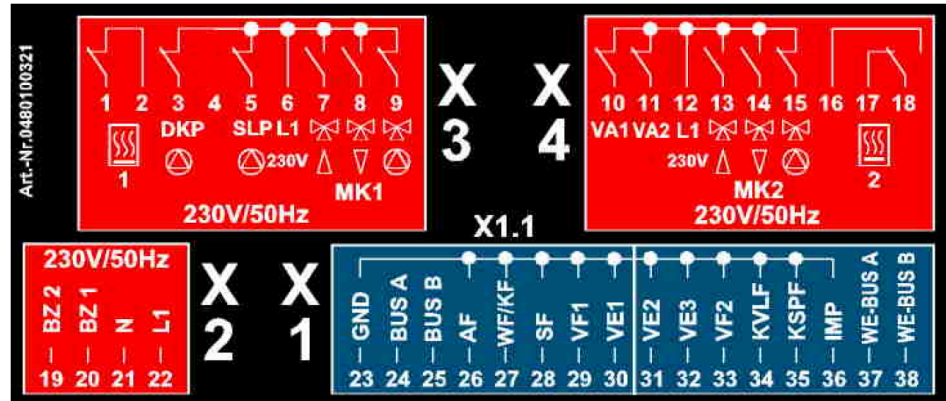

**Mains-side connection**

No.	Connection
1	Heat generator relay output (T2), stage 1; for district heating controllers, district heating valve CLOSED
2	Heat generator relay input (T1), stage 1; for district heating controllers L1
3	Direct heating circuit pump
4	Not occupied
5	Hot-water charging pump
6	L1 / 230 V
7	Mixer motor 1 OPEN
8	Mixer motor 1 CLOSED
9	Mixed heating circuit pump 1
10	Variable output 1
11	Variable output 2
12	L1 / 230 V
13	Mixer motor 2 OPEN
14	Mixer motor 2 CLOSED
15	Mixed heating circuit pump 2
16	Stage 2 (T7); for district heating controllers, district heating valve OPEN
17	Heat generator relay output (T8), stage 2
18	Heat generator relay input (T6), stage 2; for district heating controllers L1
19	Burner operating hour counter, stage 2

No.	Connection
20	Burner operating hour counter, stage 1
21	N / 230 V
22	L1 / 230 V mains connection

**Sensor / data bus connection**

No.	Connection
23	Common sensor ground
24	Bus side A
25	Bus side B
26	Outside sensor
27	Heat generator sensor/Boiler sensor
28	Hot-water sensor
29	Mixed heating circuit 1 flow sensor
30	Variable input 1
31	Variable input 2
32	Variable input 3, VFB*
33	Mixed heating circuit 2 flow sensor
34	Collector flow sensor (solar application, PT 1000)
35	Collector return sensor (solar application)
36	Pulse input
37	OpenTherm A
38	OpenTherm B

\* with district heating controllers

#### 4.1 With wall base for heating / district heating applications

X5		X6		X7		X8		X9		X10	
1	Bus B	1	Bus A	1	T1	1	T2/V1 ▼	1	N	1	PE
2	GND	2	AF	2		2	DKP	2	N	2	PE
3	GND	3	WF/KF	3		3	SLP	3	N	3	PE
4	GND	4	SF	4		4	MK1 ▲	4	N	4	PE
5	GND	5	VF1	5	L1	5	MK1 ▼	5	N	5	PE
6	GND	6	VE1	6		6	P1	6	N	6	PE
7	GND	7	VE2	7		7	VA1	7	N	7	PE
8	GND	8	VE3	8		8	VA2	8	N	8	PE
9	GND	9	VF 2	9	T6	9	MK2 ▲	9	N	9	PE
10	GND	10	KVLF	10	T8	10	MK2 ▼	10	N	10	PE
11	GND	11	KSPF	11	T7/V1 ▲	11	P2	11	N	11	PE
12	GND	12	IMP					12	N	12	PE
								13	N	13	PE

Bridge for district heating controllers

▲ OPEN

▼ CLOSED

Brief description	Meaning
T2B A, Bus A	Data bus connection A
T2B B, Bus B	Data bus connection B
AF	Outside sensor, GND connection on X5
WF / KF	Heat generator sensor, GND connection on X5
SF	Tank sensor, GND connection on X5
VF1	Mixed heating circuit 1 flow sensor, GND connection on X5
VE1	Variable input 1, GND connection on X5
VE2	Variable input 2, GND connection on X5
VE3	Variable input 3, VFB*, GND connection on X5
VF2	Mixed heating circuit 2 flow sensor, GND connection on X5
KVLF	Collector flow sensor, GND connection on X5
KSPF	Collector tank/buffer sensor, GND connection on X5
IMP	Pulse input, GND connection on X5
T1	Burner connection (T1), stage 1; for district heating controllers L1

<b>Brief description</b>	<b>Meaning</b>
T2	Burner connection (T2), stage 1; for district heating controllers, district heating valve V1 CLOSED, N on X9, PE on X10
T6	Burner connection (T6), stage 2; for district heating controllers L1
T7	Burner connection (T7), stage 2; for district heating controllers, district heating valve V1 OPEN
T8	Burner connection (T8), stage 2
DKP	Direct heating circuit pump, connections N and PE on X9 / X10
SLP	Tank charging pump, connections N and PE on X9 / X10
MKP1	Mixed heating circuit 1 pump, connections N and PE on X9 / X10
MK1 OPEN	Mixer open - mixed heating circuit 1, connections N and PE on X9 / X10
MK1 CLOSED	Mixer closed - mixed heating circuit 1, connections N and PE on X9 / X10
VA1	Variable output 1, connections N and PE on X9 / X10
VA2	Variable output 2, connections N and PE on X9 / X10
MKP 2	Mixed heating circuit 2 pump, connections N and PE on X9 / X10
MK2 OPEN	Mixer open - mixed heating circuit 2, connections N and PE on X9 / X10
MK2 CLOSED	Mixer closed - mixed heating circuit 2, connections N and PE on X9 / X10
VFB	Inlet temperature limit sensor
GND	Ground terminals bridged for sensor inputs
N	Neutral wire bridged for connected pumps / mixers
L1	230 V mains connection



Brief description	Meaning
PE	PE conductor bridged for connected pumps / mixers

\* with district heating controllers

#### 4.2 Connection of a safety device to the drive at district heating controllers

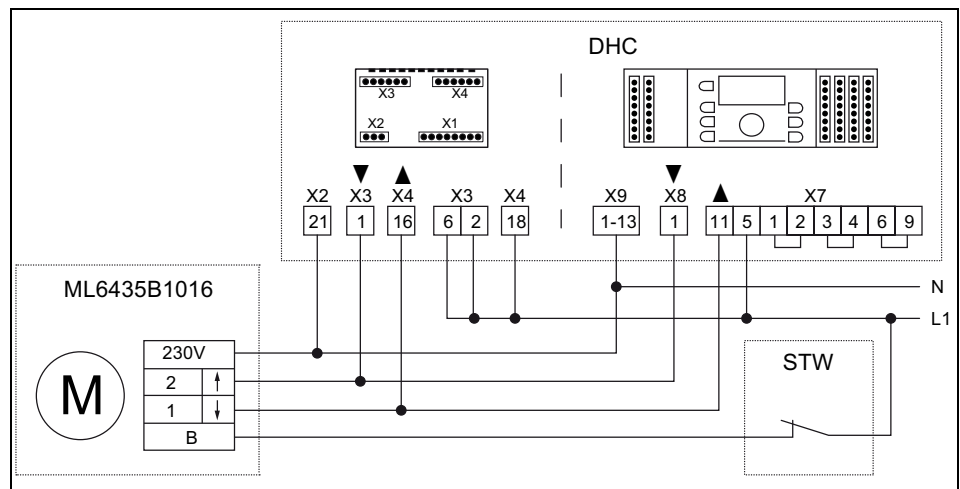

## 5 Selection of parameter presettings for a hydraulic unit

In the state of delivery, each controller type covers multiple hydraulic units. Each hydraulic unit can be changed or expanded by changing and/or adding parameters.

A hydraulic unit is selected with parameter 01 in the "Hydraulics" menu. The corresponding inputs and outputs are assigned automatically based on the hydraulics schematic.

This function simplifies the setting of a documented hydraulic unit considerably.

Additional applications can be covered by setting the individual parameters. Where necessary, the parameters are also specified in these mounting instructions. A description of how to access parameter settings can be found in the parameter list.

### Operation

Operating information	Menu	Parameter	Enter schematic, e.g.
Hydraulics preselection	"Hydraulics"	01	0201

## 6 Applications

See chapter 10 Heizungs-Applikationen / Heating applications pg. 46 and chapter 11 Fernheizungs-Applikationen / District heating applications pg. 72.

## 7 Technical data

### 7.1 General

<b>Mains connection voltage</b>	230 V +6 % / -10 %
<b>Rated frequency</b>	50 ... 60 Hz
<b>Power consumption</b>	max. 5.8 VA
<b>Pre-fuse</b>	max. 6.3 A slow-blowing
<b>Contact load of the output relays</b>	2 (2) A
<b>Bus interface</b>	For the connection of external devices (wall device, PC, modem or gateway)
<b>Max. bus length</b>	50 m
<b>Power supply via bus</b>	12 V / 150 mA
<b>Ambient temperature</b>	0 ... +50°C
<b>Storage temperature</b>	-25 ... +60°C
<b>Degree of protection</b>	IP 30
<b>Protection class as per EN 60730</b>	II
<b>Protection class as per EN 60529</b>	III
<b>Radio protection</b>	EN 55014 (1993)
<b>Interference resistance</b>	EN 55104 (1995)
<b>EC conformity</b>	89/336/EEC
<b>Housing dimensions</b>	144 x 96 x 75 mm (W x H x D)
<b>Housing material</b>	ABS with static inhibitor
<b>Connection technology</b>	Plug-in screw terminal connections

## 7.2 Sensor resistance values

### 7.2.1 NTC 20

For outside sensor (OT), heat generator sensor (BLRS/BS), tank sensor (DHWS), mixed heating circuit 1 flow sensor (VF1), mixed heating circuit 2 flow sensor (VF2), variable input 1 (VI-1) (setting not for exhaust gas sensor), variable input 2 (VI-2), variable input 3 (VI-3), collector tank/buffer sensor (SBUS).

°C	kΩ	°C	kΩ	°C	kΩ	°C	kΩ
-20	220.6	0	70.20	20	25.34	70	3.100
-18	195.4	2	63.04	25	20.00	75	2.587
-16	173.5	4	56.69	30	15.88	80	2.168
-14	154.2	6	51.05	35	12.69	85	1.824
-12	137.3	8	46.03	40	10.21	90	1.542
-10	122.4	10	41.56	45	8.258	95	1.308
-8	109.2	12	37.55	50	6.718	100	1.114
-6	97.56	14	33.97	55	5.495	–	–
-4	87.30	16	30.77	60	4.518	–	–
-2	78.23	18	27.90	65	3.734	–	–

### 7.2.2 PT 1000

For variable input 1 (VI-1) (setting of exhaust gas sensor), collector flow sensor (SPFS).

°C	Ω	°C	Ω	°C	Ω	°C	Ω
0	1000.00	80	1308.93	140	1535.75	280	2048.76
10	1039.02	85	1327.99	150	1573.15	300	2120.19
20	1077.93	90	1347.02	160	1610.43	320	2191.15
25	1093.46	95	1366.03	170	1647.60	340	2261.66
30	1116.72	100	1385.00	180	1684.65	360	2331.69
40	1155.39	105	1403.95	190	1721.58	380	2401.27
50	1193.95	110	1422.86	200	1758.40	400	2470.38
60	1232.39	115	1441.75	220	1831.68	450	2641.12
70	1270.72	120	1460.61	240	1904.51	500	2811.00
75	1289.84	130	1498.24	260	1976.86	–	–

### 7.3 Sensor measurement ranges

Designation	Brief description	Sensor type	Measurement range
Outside sensor	AF	NTC 20	-50 °C to 90 °C
Heat generator sensor	KF	NTC 20	-50 °C to 120 °C
Flow sensor 1	VF1	NTC 20	-50 °C to 120 °C
Flow sensor 2	VF2	NTC 20	-50 °C to 120 °C
Tank sensor	SF	NTC 20	-50 °C to 120 °C
Collector flow sensor	KVLF	PT 1000	-50 °C to 210 °C
Collector tank / buffer sensor	KSPF	NTC 20	-50 °C to 120 °C
Variable input VI-1*	VE1	NTC 20	-50 °C to 120 °C
		PT 1000	-50 °C to 500 °C
Variable input VI-2	VE2	NTC 20	-50 °C to 120 °C
Variable input VI-3	VE3	NTC 20	-50 °C to 120 °C

\* Depending on the selection of the assigned function.  
PT 1000 e.g. for exhaust gas sensor connection.

### 7.4 Digital inputs

Designation	Brief description	Input type	Measurement range
Impulse metering unit	Imp	Extra-low voltage	≤ 10 Hz
Burner stage 1 operating hour counter	BZ1	230 V	OFF, ON
Burner stage 2 operating hour counter	BZ2	230 V	OFF, ON

## 8 Connection of Room Devices

For Smile controllers several variants of room devices (wall modules) are provided.

### 8.1 Room Sensor RF20

#### Configuration:

Configuration and allocation is done via parameter 08, 09 or 10 in the “Hydraulic” menu.

Electrical connection occurs according to the assignment to variable input 1 (VE1) ... variable input 3 (VE3) (Wall socket).

**Example:** Assignment of room sensor to input VE1

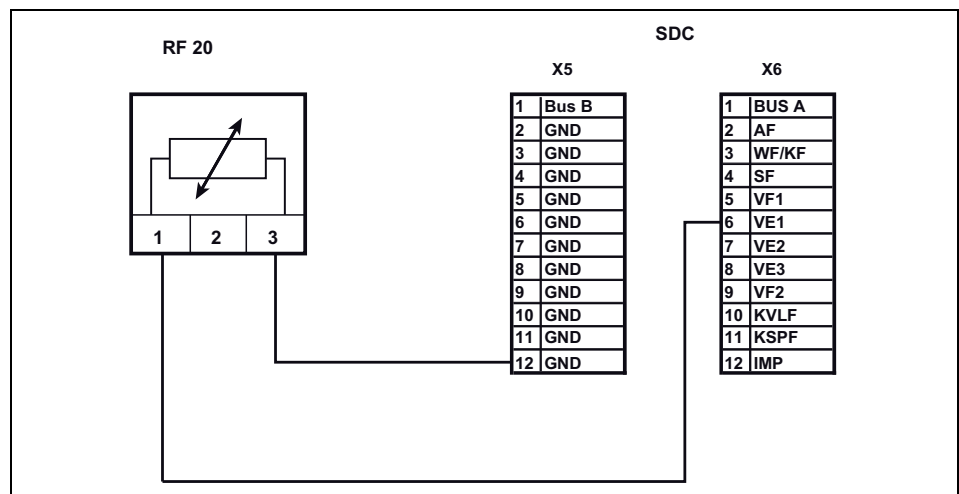

1 Actual value

3 GND

## 8.2 Wall Module TF 22 / TFU 22

### Configuration

Configuration and allocation is done via parameter 08, 09 or 10 in the “Hydraulic” menu.

For any of the signals "Room temperature" and "Setpoint" one variable input must be assigned.

The parameter setting in the “Hydraulic” menu for room sensor is 30 (for direct heating circuit), 31 (for mixing circuit 1) or 32 (for mixing circuit 2).

The parameter setting in the “Hydraulic” menu for “Setpoint deviation” and “Operating mode” is 50 (for direct heating circuit), 51 (for mixing circuit 1) and 52 (for mixing circuit 2).

Electrical connection occurs according to the assignment to variable input 1 (VE1) ... variable input 3 (VE3) (Wall socket).

**Example:** Assignment of TF 22 to mixing circuits 1 (room sensor to VE1 and setpoint / operating mode to VE2)

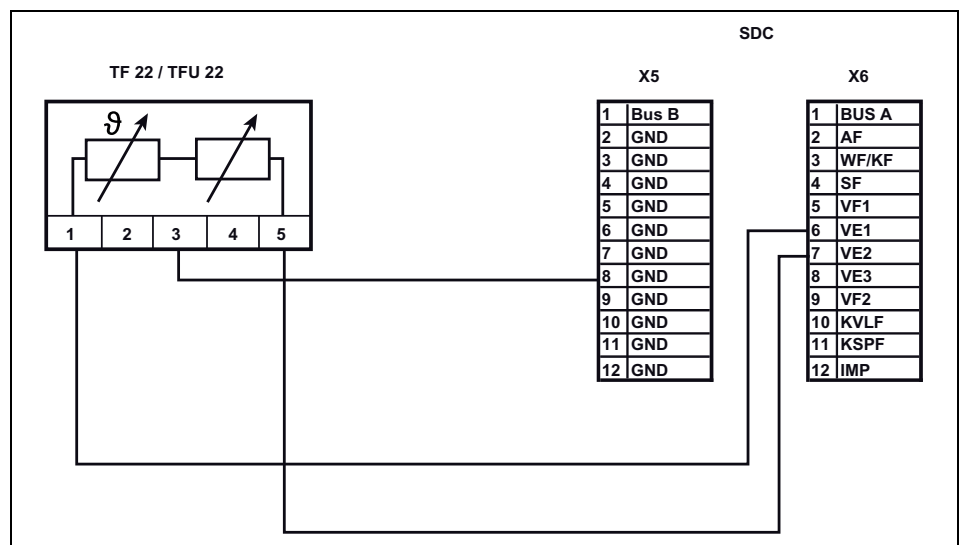

- 1 Actual value
- 3 GND
- 5 Setpoint and operating mode

### 8.3 Wall Module SDW 10 / SDW 30

#### Configuration

Configuration of wall module SD 10 / SD 30 is done via parameter 03 of the heating- or mixing circuit on the controller. In addition, a bus address must be selected at the wall module.

The assignment of a bus address occurs as follows:

Controller with bus address 10 (default) communicate with wall modules having bus address 1 (for direct heating circuits, 2 (for mixing circuit 1) or 3 (for mixing circuit 2).

#### Bus address assignment

SDW 10 bus address	Central controller		Heating circuit
	No.	Bus address	
1	1	10	Unmixed heating circuit
2	1	10	Mixed heating circuit 1
3	1	10	Mixed heating circuit 2
4	2	20	Unmixed heating circuit
5	2	20	Mixed heating circuit 1
6	2	20	Mixed heating circuit 2
7	3	30	Unmixed heating circuit
8	3	30	Mixed heating circuit 1
9	3	30	Mixed heating circuit 2
A	4	40	Unmixed heating circuit
B	4	40	Mixed heating circuit 1
C	4	40	Mixed heating circuit 2
D	5	50	Unmixed heating circuit
E	5	50	Mixed heating circuit 1
F	5	50	Mixed heating circuit 2
0	undefined		undefined



For the wall module SDW 30 the access rights can be set via parameters 02 ... 03 in the "Data bus" menu.

The electrical connection of the wall modules SDW 10 and SDW 30 is done using the bus terminals A and B:

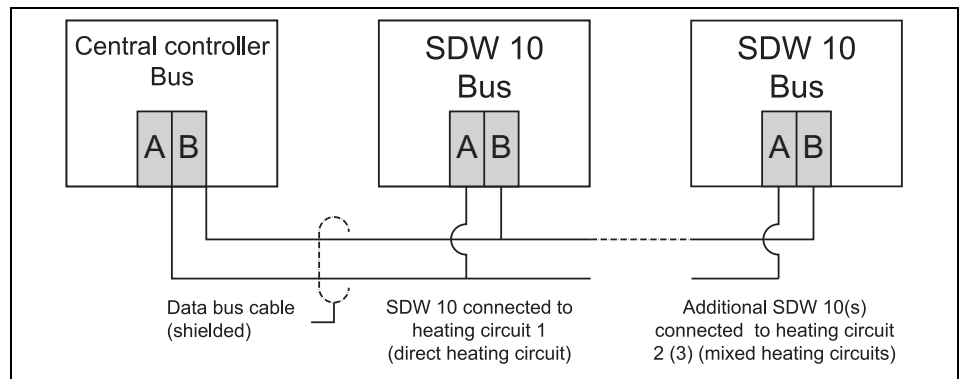

## 9 Montage / Installation

### 9.1 Wandmontage / Wall installation

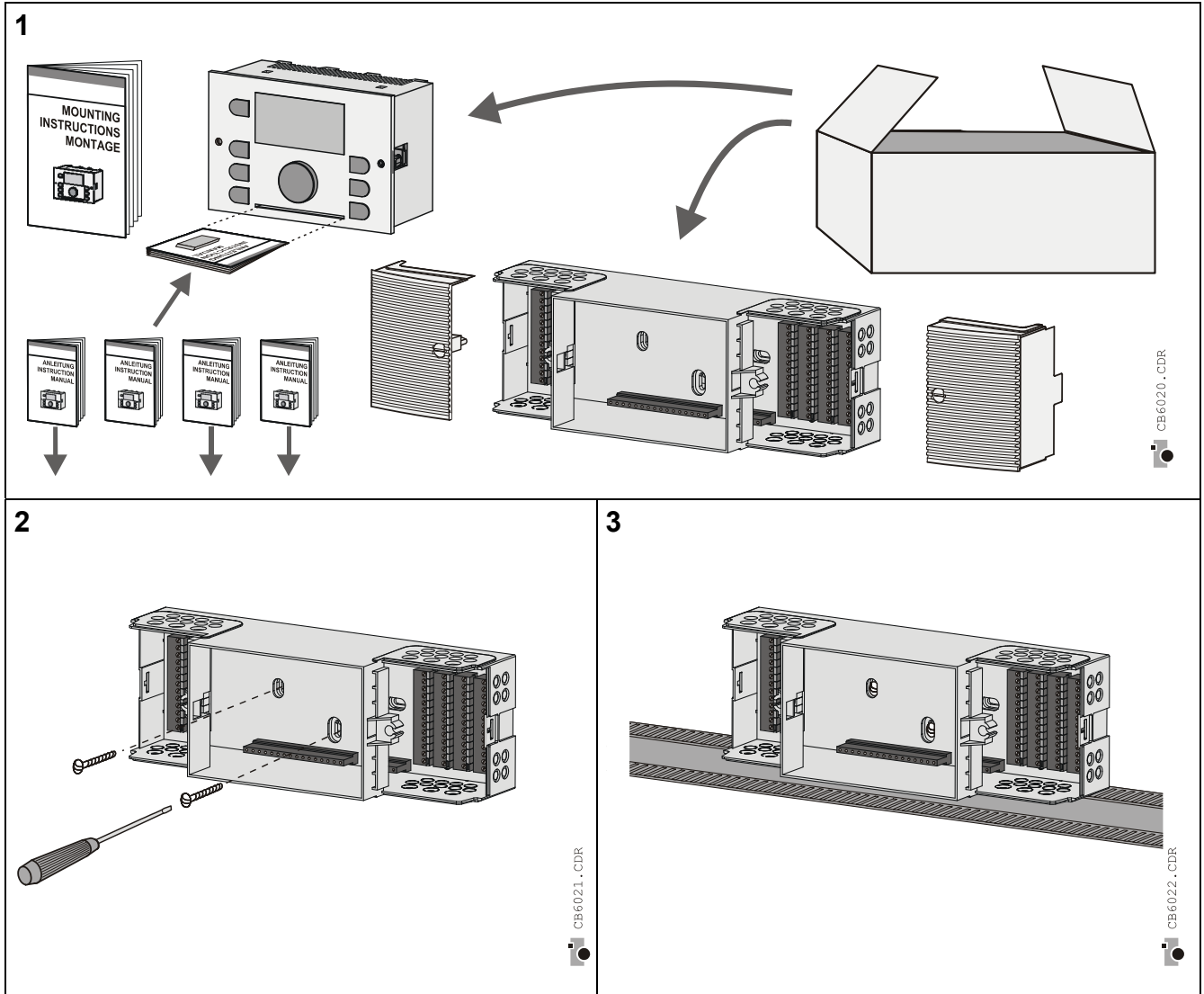

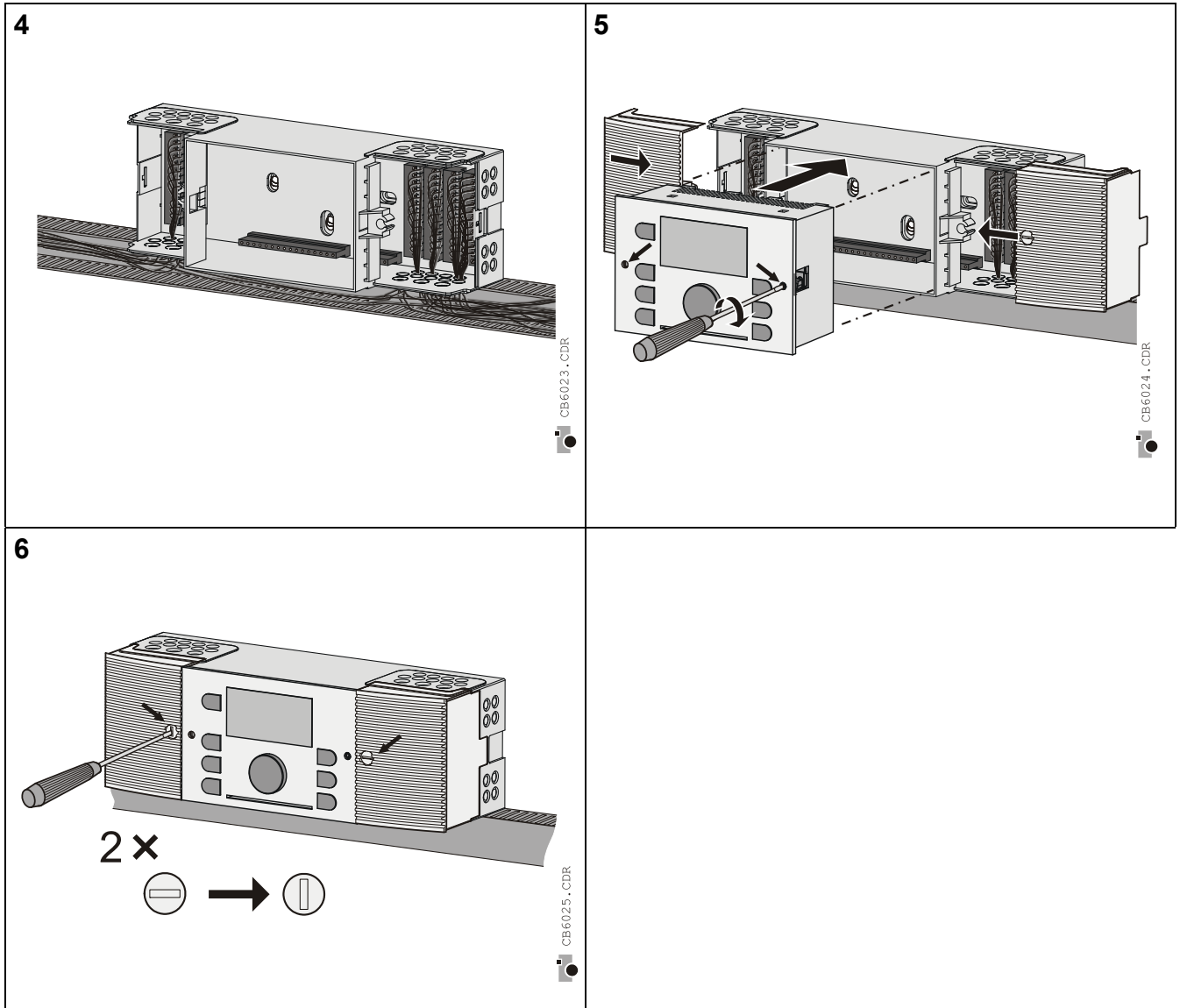

### 9.2 Schaltschrankeinbau / Panel mounted installation

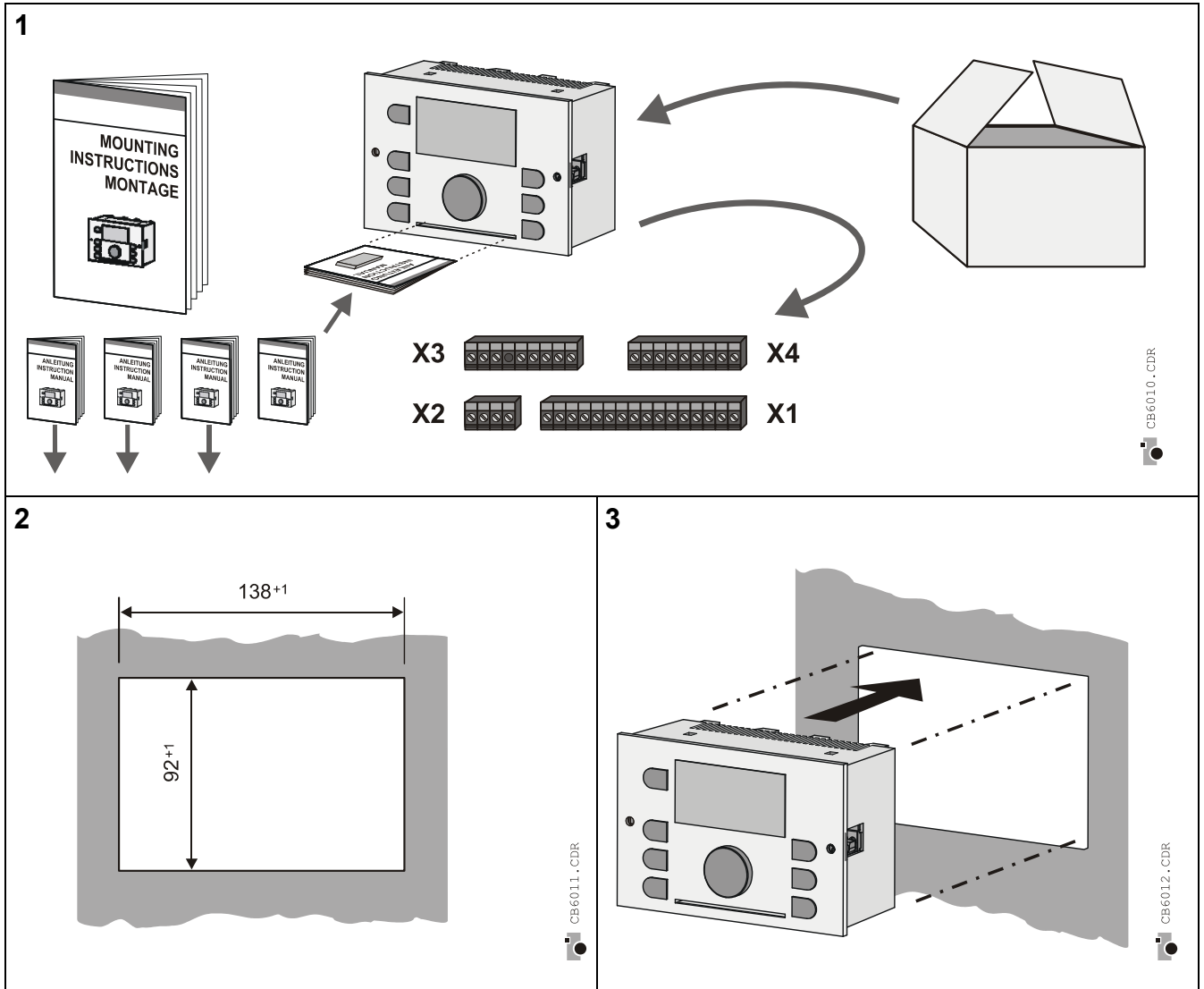

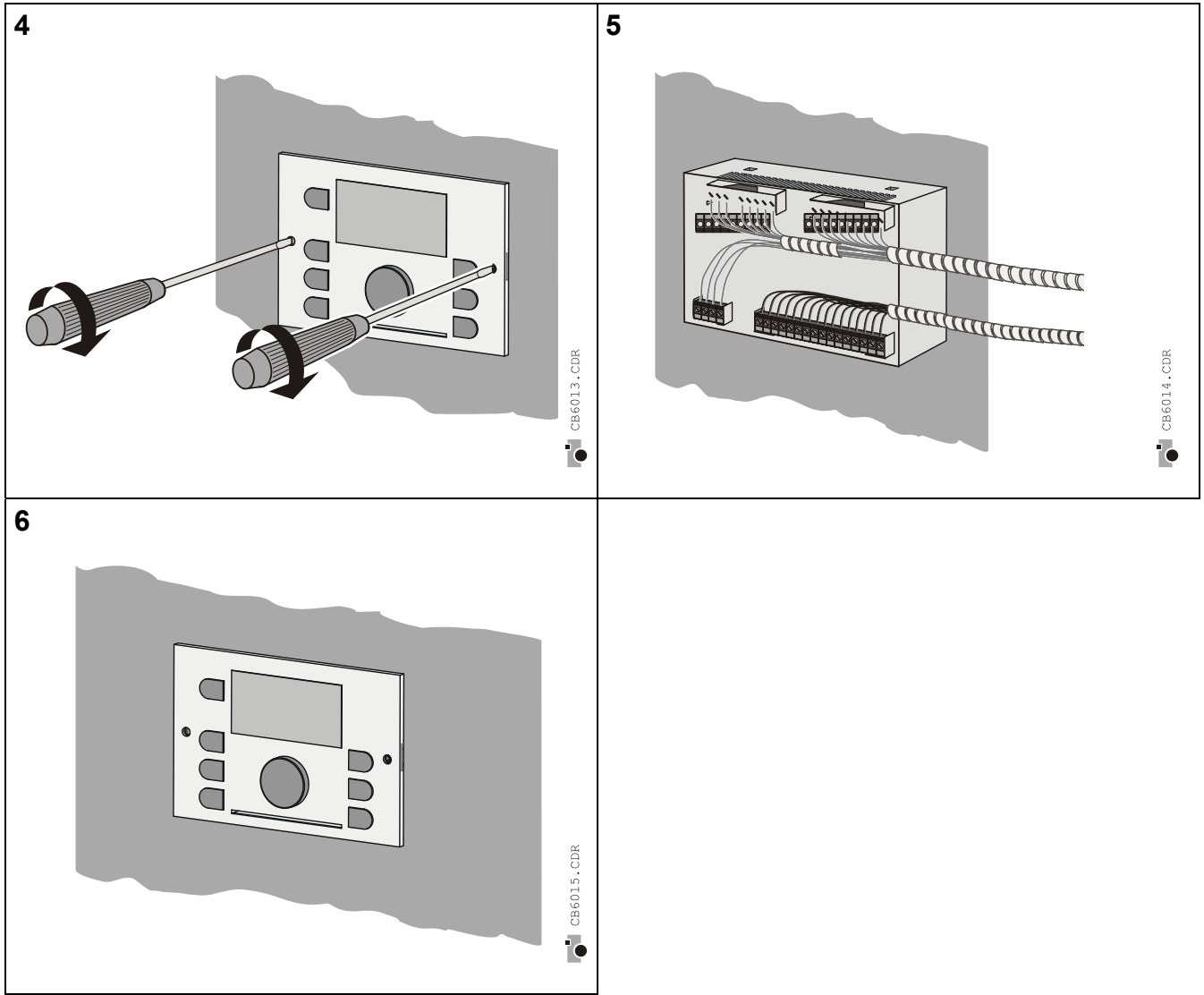

## 10 Heizungs-Applikationen / Heating applications

### 10.1 Übersicht / Overview

Hydraulik Hydraulics	Typ Type	Seite Page
0101	SDC 3-10	47
0201	SDC 7-21	48
0202	SDC 7-21 SDC 9-21	49
0302	SDC 12-31	50
0303	SDC 12-31	51
0305 Kesselfolge mit Heizkreisen und Warmwasserkreis / Boiler sequence with heating circuits and hot-water circuit	2 x SDC 12-31 1 x SDC 3-40	53
0401	SDC 3-40	59
0403	SDC 9-21	60
0404	SDC 9-21	62
0405	SDC 12-31	64
0406	SDC 7-21	66
0407	SDC 9-21	69

10.2 Hydraulik 0101 (SDC 3-10) / Hydraulics 0101 (SDC 3-10)

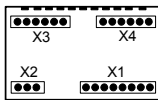
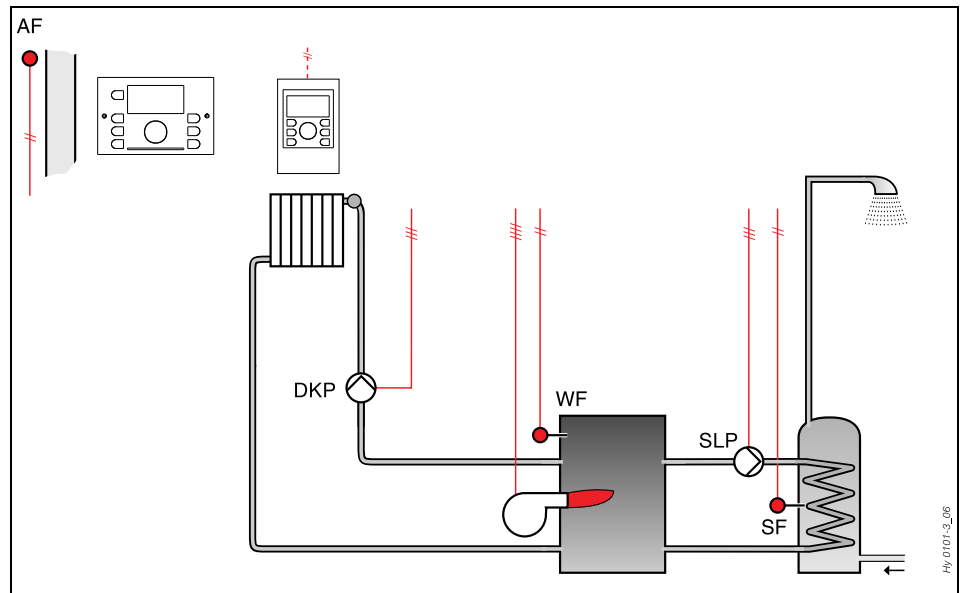

X 1		X 2		X 3		X 4	
23	GND	19		1	T2	10	
24	BUS A	20		2	T1	11	
25	BUS B	21	N	3	DKP	12	
26	AF	22	L1	4		13	
27	WF			5	SLP	14	
28	SF			6	L 1	15	
29				7		16	
30				8		17	
31				9		18	
32							
33							
34							
35							
36							
37							
38							

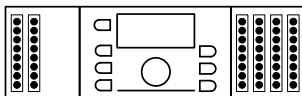

X 5		X 6		X 7		X 8		X 9		X 10	
1	Bus B	1	Bus A	1	T1	1	T2	1	N	1	PE
2	GND	2	AF	2		2	DKP	2	N	2	PE
3	GND	3	WF	3		3	SLP	3	N	3	PE
4	GND	4	SF	4		4		4	N	4	PE
5	GND	5		5	L 1	5		5	N	5	PE
6	GND	6		6		6		6	N	6	PE
7	GND	7		7		7		7	N	7	PE
8	GND	8		8		8		8	N	8	PE
9	GND	9		9		9		9	N	9	PE
10	GND	10		10		10		10	N	10	PE
11	GND	11		11		11		11	N	11	PE
12	GND	12						12	N	12	PE
								13	N	13	PE

### 10.3 Hydraulik 0201 (SDC 7-21) / Hydraulics 0201 (SDC 7-21)

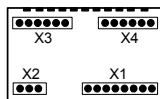
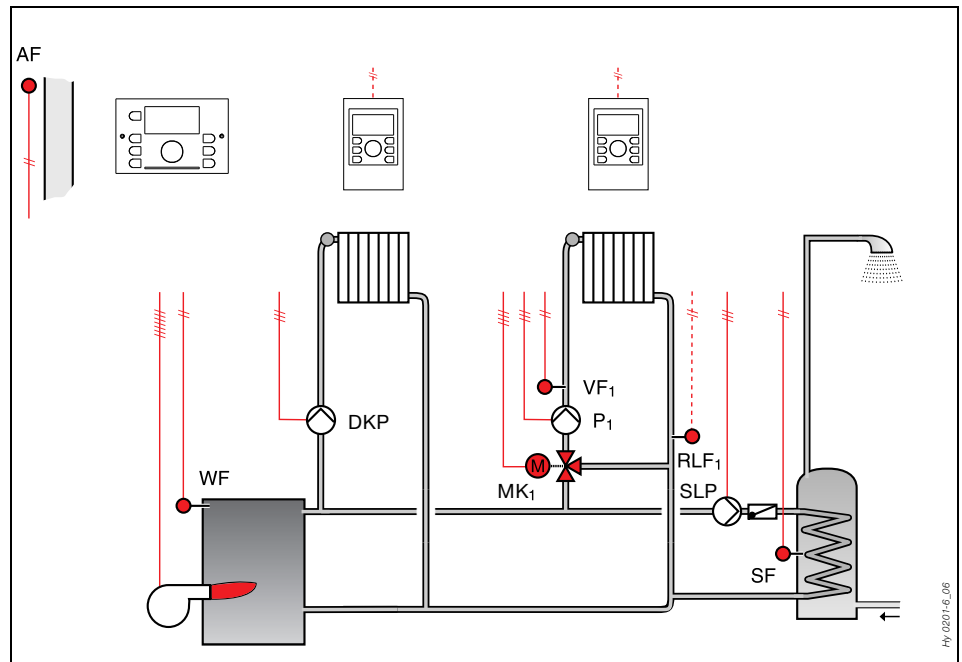

X 1		X 2		X 3		X 4	
23	GND	19		1	T2	10	
24	BUS A	20		2	T1	11	
25	BUS B	21	N	3	DKP	12	
26	AF	22	L1	4		13	
27	WF			5	SLP	14	
28	SF			6	L 1	15	
29	VF1			7	MK1▲	16	
30	RLF1			8	MK1▼	17	
31				9	P1	18	
32							
33							
34							
35							
36							
37							
38							

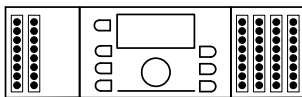

X 5		X 6		X 7		X 8		X 9		X 10	
1	Bus B	1	Bus A	1	T1	1	T2	1	N	1	PE
2	GND	2	AF	2		2	DKP	2	N	2	PE
3	GND	3	WF	3		3	SLP	3	N	3	PE
4	GND	4	SF	4		4	MK1▲	4	N	4	PE
5	GND	5	VF1	5	L 1	5	MK1▼	5	N	5	PE
6	GND	6	RLF1	6		6	P 1	6	N	6	PE
7	GND	7		7		7		7	N	7	PE
8	GND	8		8		8		8	N	8	PE
9	GND	9		9		9		9	N	9	PE
10	GND	10		10		10		10	N	10	PE
11	GND	11		11		11		11	N	11	PE
12	GND	12						12	N	12	PE
								13	N	13	PE



### 10.4 Hydraulik 0202 (SDC 7-21 / SDC 9-21) Hydraulics 0202 (SDC 7-21 / SDC 9-21)

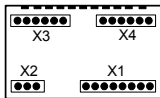
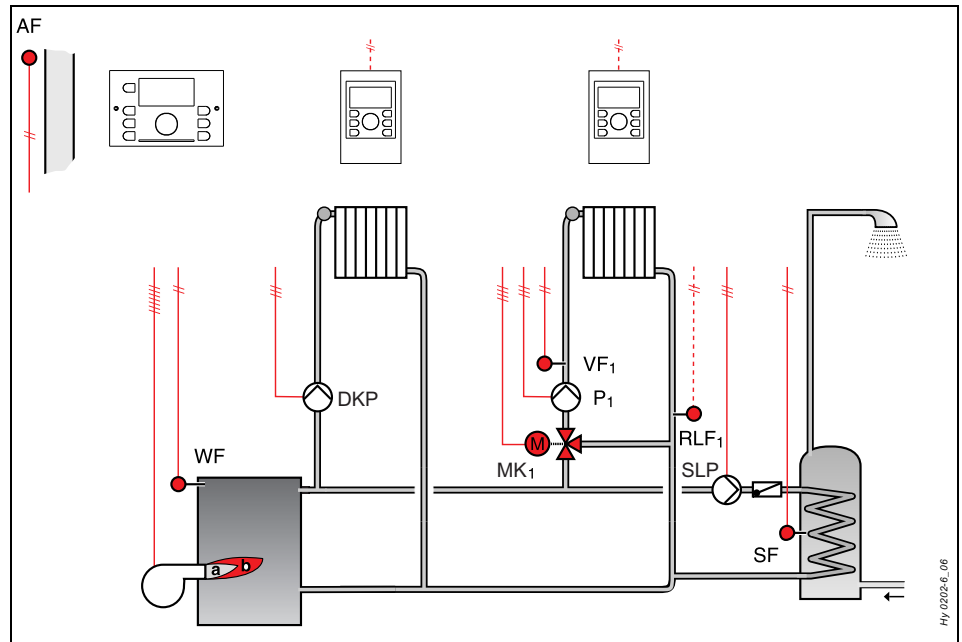

X 1		X 2		X 3		X 4	
23	GND	19		1	T2	10	P6
24	BUS A	20		2	T1	11	P5
25	BUS B	21	N	3	DKP	12	L1
26	AF	22	L1	4	DKP	13	
27	WF			5	SLP	14	
28	SF			6	L 1	15	
29	VF1			7	MK1▲	16	T7
30	RLF1			8	MK1▼	17	T8
31				9	P1	18	T6
32							
33							
34							
35							
36							
37							
38							

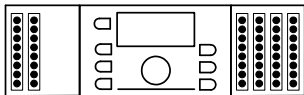

X 5		X 6		X 7		X 8		X 9		X 10	
1	Bus B	1	Bus A	1	T1	1	T2	1	N	1	PE
2	GND	2	AF	2		2	DKP	2	N	2	PE
3	GND	3	WF	3		3	SLP	3	N	3	PE
4	GND	4	SF	4		4	MK1▲	4	N	4	PE
5	GND	5	VF 1	5	L 1	5	MK1▼	5	N	5	PE
6	GND	6	RLF1	6		6	P 1	6	N	6	PE
7	GND	7		7		7		7	N	7	PE
8	GND	8		8		8		8	N	8	PE
9	GND	9		9	T6	9		9	N	9	PE
10	GND	10		10	T8	10		10	N	10	PE
11	GND	11		11	T7	11		11	N	11	PE
12	GND	12						12	N	12	PE
								13	N	13	PE

### 10.5 Hydraulik 0302 (SDC 12-31) / Hydraulics 0302 (SDC 12-31)

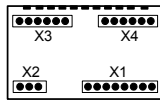
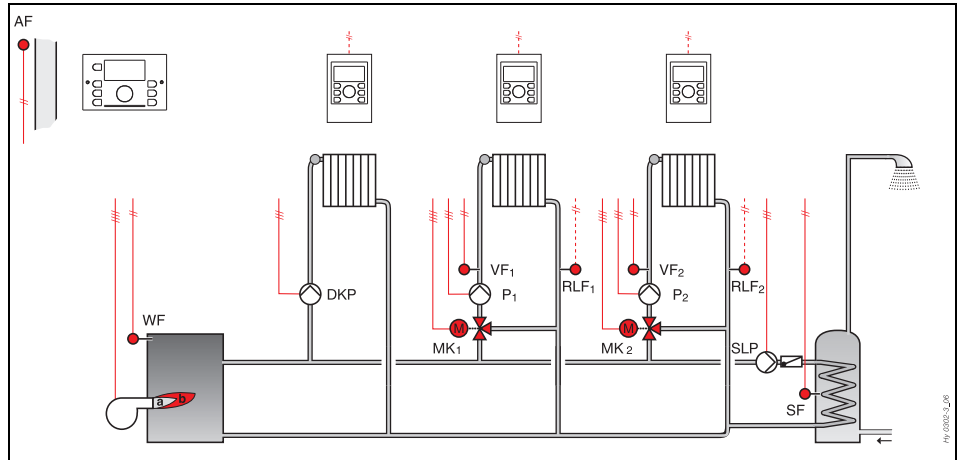

X 1		X 2		X 3		X 4	
23	GND	19		1	T2	10	
24	BUS A	20		2	T1	11	
25	BUS B	21	N	3	DKP	12	L1
26	AF	22	L1	4		13	MK2 ▲
27	WF			5	SLP	14	MK2 ▼
28	SF			6	L 1	15	P2
29	VF1			7	MK1 ▲	16	T7
30	RLF1			8	MK1 ▼	17	T8
31	RLF2			9	P1	18	T6
32							
33	VF2						
34							
35							
36							
37							
38							

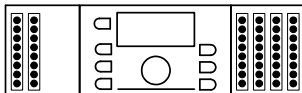

X 5		X 6		X 7		X 8		X 9		X 10	
1	Bus B	1	Bus A	1	T1	1	T2	1	N	1	PE
2	GND	2	AF	2		2	DKP	2	N	2	PE
3	GND	3	WF	3		3	SLP	3	N	3	PE
4	GND	4	SF	4		4	MK1 ▲	4	N	4	PE
5	GND	5	VF 1	5	L 1	5	MK1 ▼	5	N	5	PE
6	GND	6	RLF1	6		6	P 1	6	N	6	PE
7	GND	7	RLF2	7		7		7	N	7	PE
8	GND	8		8		8		8	N	8	PE
9	GND	9	VF2	9	T6	9	MK2 ▲	9	N	9	PE
10	GND	10		10	T8	10	MK2 ▼	10	N	10	PE
11	GND	11		11	T7	11	P2	11	N	11	PE
12	GND	12						12	N	12	PE
								13	N	13	PE

### 10.6 Hydraulik 0303 (SDC 12-31) / Hydraulics 0303 (SDC 12-31)

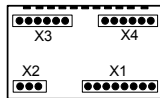
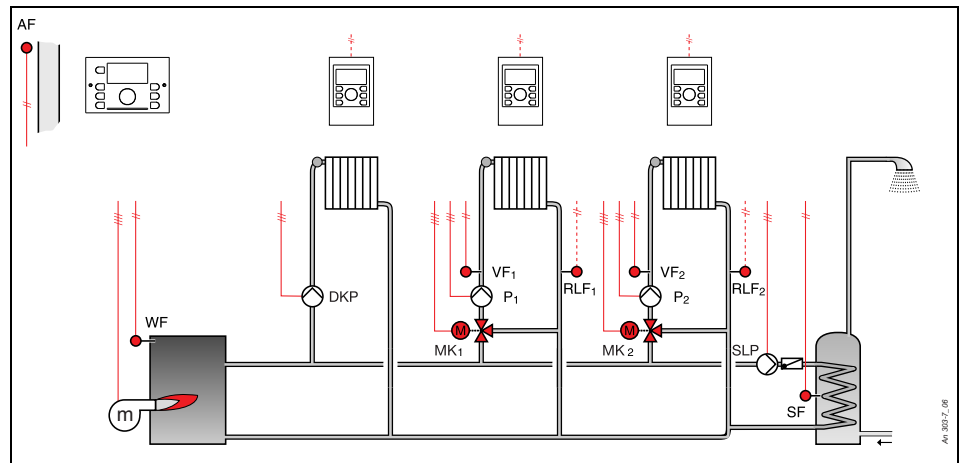

X 1		X 2		X 3		X 4	
23	GND	19	///	1	T2	10	VA1* ▼
24	BUS A	20	///	2	T1	11	
25	BUS B	21	N	3	DKP	12	L1
26	AF	22	L1	4	///	13	MK2▲
27	WF			5	SLP	14	MK2▼
28	SF			6	L 1	15	P2
29	VF1			7	MK1▲	16	T7* ▲
30	RLF1			8	MK1▼	17	T8
31	RLF2			9	P1	18	T6
32							
33	VF2						
34							
35							
36							
37	///						
38	///						

\* Modulation / modulation

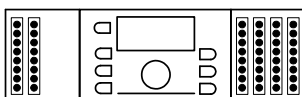

X 5		X 6		X 7		X 8		X 9		X 10	
1	Bus B	1	Bus A	1	T1	1	T2	1	N	1	PE
2	GND	2	AF	2		2	DKP	2	N	2	PE
3	GND	3	WF	3		3	SLP	3	N	3	PE
4	GND	4	SF	4		4	MK1▲	4	N	4	PE
5	GND	5	VF 1	5	L 1	5	MK1▼	5	N	5	PE
6	GND	6	RLF1	6		6	P 1	6	N	6	PE
7	GND	7	RLF2	7		7	VA1*▼	7	N	7	PE
8	GND	8		8		8		8	N	8	PE
9	GND	9	VF2	9	T6	9	MK2▲	9	N	9	PE
10	GND	10		10	T8	10	MK2▼	10	N	10	PE
11	GND	11		11	T7* ▲	11	P2	11	N	11	PE
12	GND	12						12	N	12	PE
								13	N	13	PE

\* Modulation / modulation

**HINWEIS**  
**NOTE**

Parametereingabe siehe 10.6.1 S. 52.  
For parameter entry, see 10.6.1 pg. 52.

**10.6.1 Parametereingabe Hydraulik 0303 (SDC 12-31)**  
**Parameter entry for hydraulics 0303 (SDC 12-31)**

**Menü "Hydraulik" / "Hydraulics" menu**

<b>Parameter Parameter</b>	<b>Einstellwert Set value</b>	<b>Bemerkung</b>	<b>Remark</b>
01	0302	Basis für 0303	Basis for 0303

**Menü "Wärmeerzeuger" / "Heat generator" menu**

<b>Parameter Parameter</b>	<b>Einstellwert Set value</b>	<b>Bemerkung</b>	<b>Remark</b>
01	4	Modulierender Brenner	Modulating burner

**10.7 Hydrauliken 0305 (2 x SDC 12-31, 1 x SDC 3-40)**  
**Hydraulics 0305 (2 x SDC 12-31, 1 x SDC 3-40)**

**10.7.1 Hydraulik 0305.1 (SDC 12-31) / Hydraulics 0305.1 (SDC 12-31)**

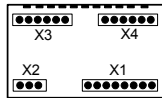
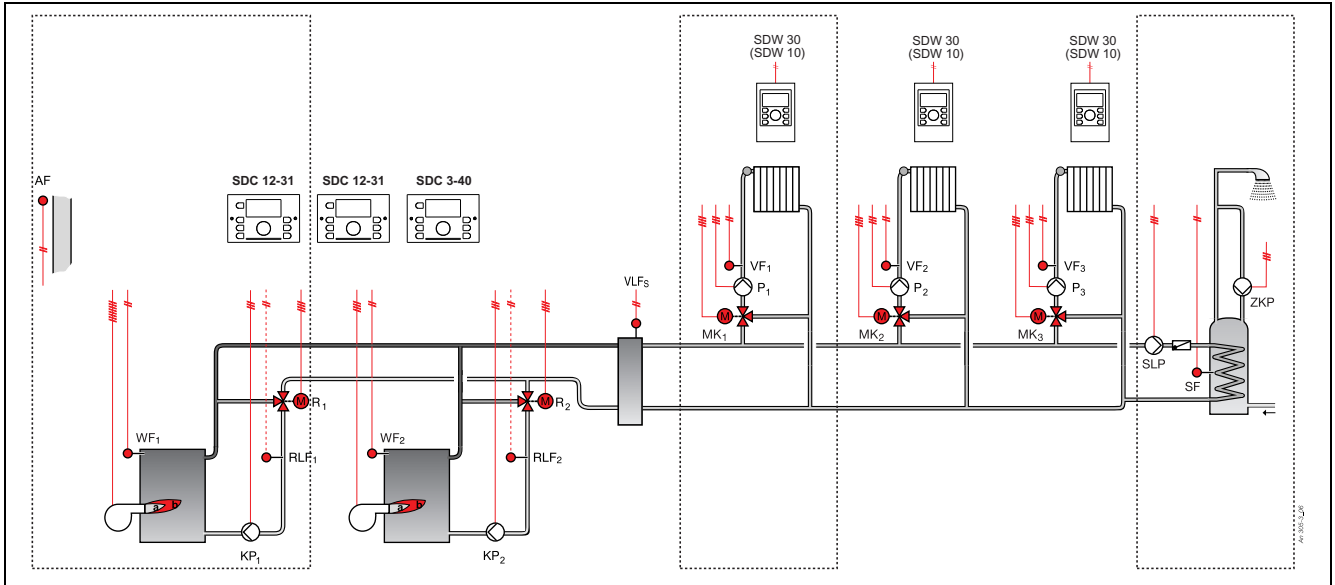

X 1		X 2		X 3		X 4	
23	GND	19	///	1	T2	10	
24	BUS A	20	///	2	T1	11	
25	BUS B	21	N	3	ZKP	12	L1
26	AF	22	L1	4	///	13	R1 ▲
27	WF1			5	SLP	14	R1 ▼
28	SF			6	L 1	15	KP1
29	VF1			7	MK1▲	16	T7
30	VFLS			8	MK1▼	17	T8
31				9	P1	18	T6
32							
33	RLF1						
34							
35							
36							
37	///						
38	///						

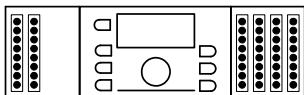

X 5		X 6		X 7		X 8		X 9		X 10	
1	Bus B	1	Bus A	1	T1	1	T2	1	N	1	PE
2	GND	2	AF	2		2	ZKP	2	N	2	PE
3	GND	3	WF 1	3		3	SLP	3	N	3	PE
4	GND	4	SF	4		4	MK1▲	4	N	4	PE
5	GND	5	VF 1	5	L 1	5	MK1▼	5	N	5	PE
6	GND	6	VFLS	6		6	P 1	6	N	6	PE
7	GND	7		7		7		7	N	7	PE
8	GND	8		8		8		8	N	8	PE
9	GND	9	RLF1	9	T6	9	R1 ▲	9	N	9	PE
10	GND	10		10	T8	10	R1 ▼	10	N	10	PE
11	GND	11		11	T7	11	KP1	11	N	11	PE
12	GND	12						12	N	12	PE
								13	N	13	PE

**HINWEIS** Parametereingabe siehe 10.7.1.1 S. 54.

**NOTE** For parameter entry, see 10.7.1.1 pg. 54.

**10.7.1.1 Parametereingabe Hydraulik 0305.1 (SDC 12-31, Regler 10)  
Parameter entry for hydraulics 0305.1 (SDC 12-31, controller 10)**

**Menü "Hydraulik" / "Hydraulics" menu**

<b>Parameter Parameter</b>	<b>Einstellwert Set value</b>	<b>Bemerkung</b>	<b>Remark</b>
01	0000	Keine Einstellung	No setting
02	1	Warmwasserladepumpe	Hot-water charging pump
03	3	Mischheizkreis witterungsgeführt	Mixed heating circuit controlled by weather conditions
04	8	Rücklaufhochhaltung	Return maintenance
05	4	Zirkulationspumpe	Circulating pump
06	AUS / OFF	Keine Funktion	No function
07	AUS / OFF	Keine Funktion	No function
08	13	Summenvorlauffühler	Total flow sensor
09 ... 11	AUS / OFF	Keine Funktion	No function

**Menü "Wärmeerzeuger" / "Heat generator" menu**

<b>Parameter Parameter</b>	<b>Einstellwert Set value</b>	<b>Bemerkung</b>	<b>Remark</b>
01	2	Öl / Gas zweistufig	Oil / gas - two stages
02	1	Uneingeschränkter Anfahrerschutz	Unlimited start-up protection
29	2	Abführung in Heizkreise	Discharge to heating circuits

**Menü "Kaskadierung" / "Cascading" menu**

<b>Parameter Parameter</b>	<b>Einstellwert Set value</b>	<b>Bemerkung</b>	<b>Remark</b>
02	10	Zuschaltverzögerung	Connection delay
03	10	Abschaltverzögerung	Deactivation delay
05	200	Stufenumkehrung	Stage reversal

10.7.2 Hydraulik 0305.2 (SDC 12-31) / Hydraulics 0305.2 (SDC 12-31)

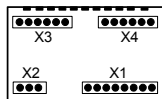
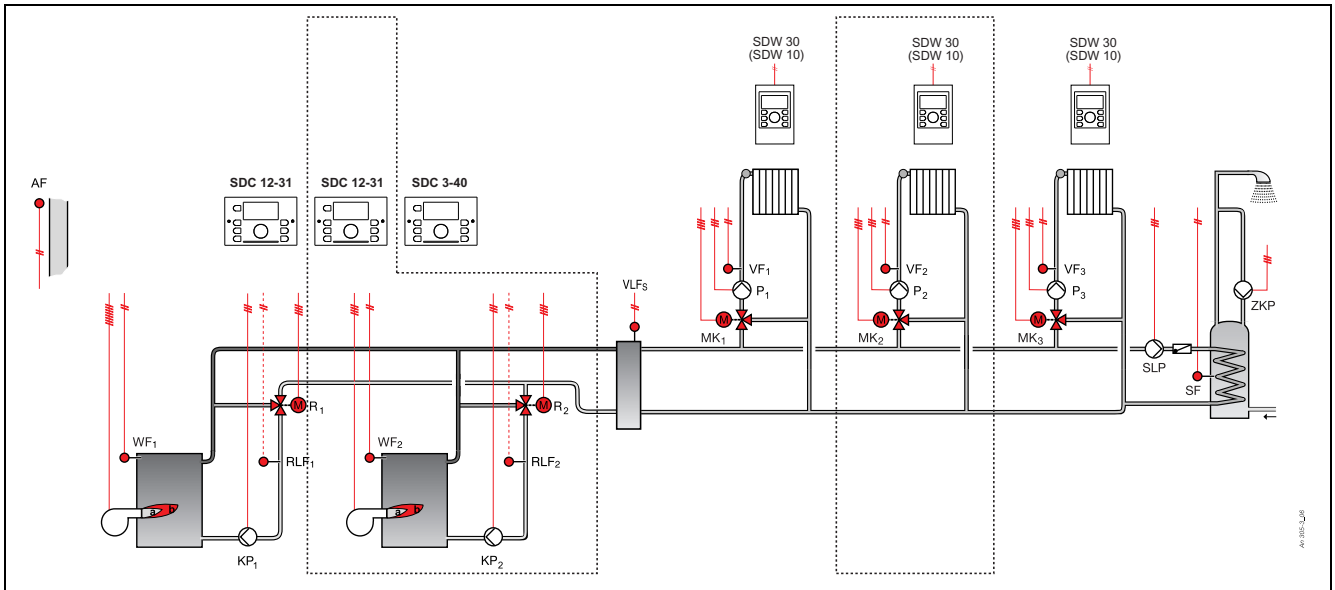

X 1		X 2		X 3		X 4	
23	GND	19	///	1	T2	10	
24	BUS A	20	///	2	T1	11	
25	BUS B	21	N	3		12	L1
26		22	L1	4	///	13	R2 ▲
27	WF2			5		14	R2 ▼
28				6	L 1	15	KP2
29	VF2			7	MK2▲	16	T7
30				8	MK2▼	17	T8
31				9	P2	18	T6
32							
33	RLF2						
34							
35							
36							
37	///						
38	///						

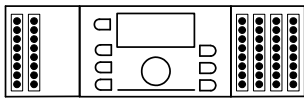

X 5		X 6		X 7		X 8		X 9		X 10	
1	Bus B	1	Bus A	1	T1	1	T2	1	N	1	PE
2	GND	2		2		2		2	N	2	PE
3	GND	3	WF 2	3		3		3	N	3	PE
4	GND	4		4		4	MK2▲	4	N	4	PE
5	GND	5	VF 2	5	L 1	5	MK2▼	5	N	5	PE
6	GND	6		6		6	P 2	6	N	6	PE
7	GND	7		7		7		7	N	7	PE
8	GND	8		8		8		8	N	8	PE
9	GND	9	RLF2	9	T6	9	R2 ▲	9	N	9	PE
10	GND	10		10	T8	10	R2 ▼	10	N	10	PE
11	GND	11		11	T7	11	KP2	11	N	11	PE
12	GND	12						12	N	12	PE
								13	N	13	PE

**HINWEIS** Parametereingabe siehe 10.7.2.1 S. 56.

**NOTE** For parameter entry, see 10.7.2.1 pg. 56.

**10.7.2.1 Parametereingabe Hydraulik 0305.2 (SDC 12-31, Regler 20)**  
**Parameter entry of hydraulics 0305.2 (SDC 12-31, controller 20)**

**Menü "Hydraulik" / "Hydraulics" menu**

<b>Parameter Parameter</b>	<b>Einstellwert Set value</b>	<b>Bemerkung</b>	<b>Remark</b>
01	0000	Keine Einstellung	No setting
02	AUS / OFF	Keine Funktion	No function
03	3	Mischheizkreis witterungsgeführt	Mixed heating circuit controlled by weather conditions
04	8	Rücklaufhochhaltung	Return maintenance
05 ... 11	AUS / OFF	Keine Funktion	No function

**Menü "Wärmeerzeuger" / "Heat generator" menu**

<b>Parameter Parameter</b>	<b>Einstellwert Set value</b>	<b>Bemerkung</b>	<b>Remark</b>
01	2	Öl / Gas zweistufig	Oil / gas - two stages
02	1	Uneingeschränkter Anfahrerschutz	Unlimited start-up protection
29	2	Abführung in Heizkreise	Discharge to heating circuits



10.7.3 Hydraulik 0305.3 (SDC 3-40) / Hydraulics 0305.3 (SDC 3-40)

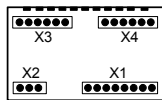
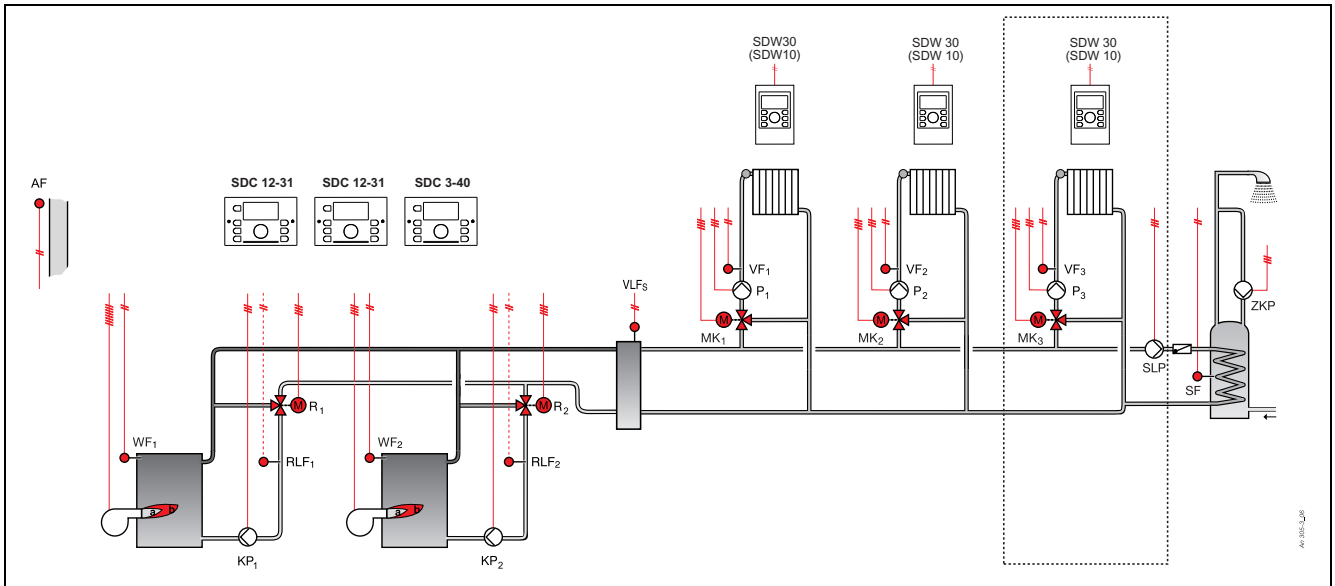

X 1		X 2		X 3		X 4	
23	GND	19	///	1		10	
24	BUS A	20	///	2		11	
25	BUS B	21	N	3		12	
26		22	L1	4	///	13	
27				5		14	
28				6	L 1	15	
29	VF3			7	MK3▲	16	
30				8	MK3▼	17	
31				9	P3	18	
32							
33							
34							
35							
36							
37	///						
38	///						

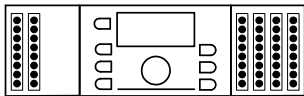

X 5		X 6		X 7		X 8		X 9		X 10	
1	Bus B	1	Bus A	1		1		1	N	1	PE
2	GND	2		2		2		2	N	2	PE
3	GND	3		3		3		3	N	3	PE
4	GND	4		4		4	MK3▲	4	N	4	PE
5	GND	5	VF 3	5	L 1	5	MK3▼	5	N	5	PE
6	GND	6		6		6	P 3	6	N	6	PE
7	GND	7		7		7		7	N	7	PE
8	GND	8		8		8		8	N	8	PE
9	GND	9		9		9		9	N	9	PE
10	GND	10		10		10		10	N	10	PE
11	GND	11		11		11		11	N	11	PE
12	GND	12						12	N	12	PE
								13	N	13	PE

**HINWEIS** Parametereingabe siehe 10.7.3.1 S. 58.

**NOTE** For parameter entry, see 10.7.3.1 pg. 58.

**10.7.3.1 Parametereingabe Hydraulik 0305.3 (SDC 3-40, Regler 30)**  
**Parameter entry of hydraulics 0305.3 (SDC 3-40, controller 30)**

Standard-Einstellungen  
Default settings

10.8 Hydraulik 0401 (SDC 3-40) / Hydraulics 0401 (SDC 3-40)

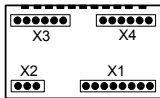
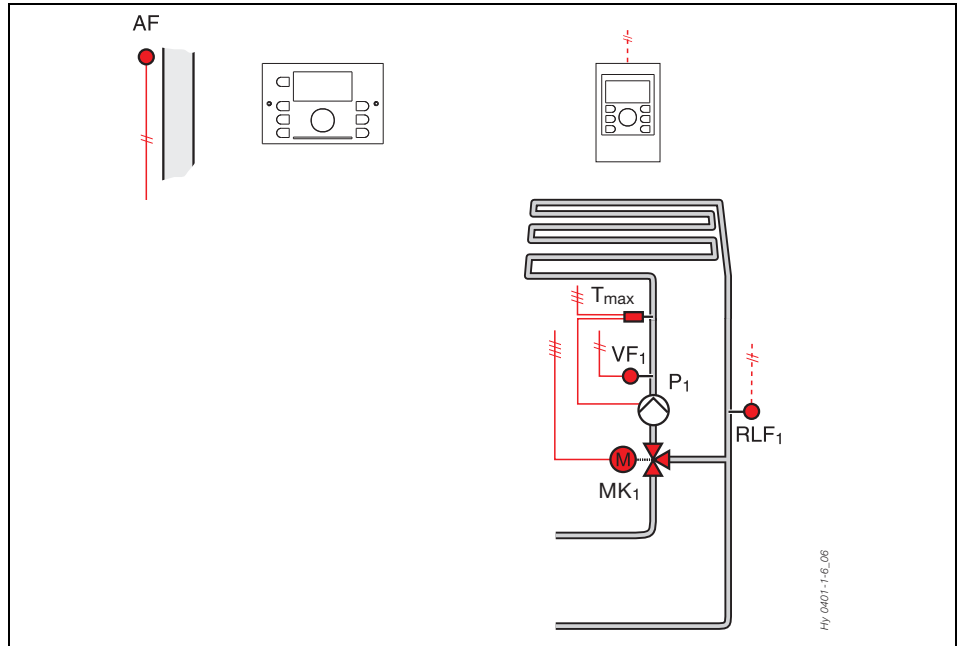

X 1		X 2		X 3		X 4	
23	GND	19		1		10	
24	BUS A	20		2		11	
25	BUS B	21	N	3		12	
26	AF	22	L1	4		13	
27				5		14	
28				6	L 1	15	
29	VF1			7	MK1▲	16	
30	RLF1			8	MK1▼	17	
31				9	P1	18	
32							
33							
34							
35							
36							
37							
38							

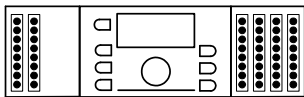

X 5		X 6		X 7		X 8		X 9		X 10	
1	Bus B	1	Bus A	1		1		1	N	1	PE
2	GND	2	AF	2		2		2	N	2	PE
3	GND	3		3		3		3	N	3	PE
4	GND	4		4		4	MK1▲	4	N	4	PE
5	GND	5	VF 1	5	L 1	5	MK1▼	5	N	5	PE
6	GND	6	RLF1	6		6	P 1	6	N	6	PE
7	GND	7		7		7		7	N	7	PE
8	GND	8		8		8		8	N	8	PE
9	GND	9		9		9		9	N	9	PE
10	GND	10		10		10		10	N	10	PE
11	GND	11		11		11		11	N	11	PE
12	GND	12						12	N	12	PE
								13	N	13	PE

### 10.9 Hydraulik 0403 (SDC 9-21) / Hydraulics 0403 (SDC 9-21)

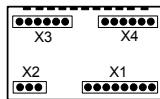
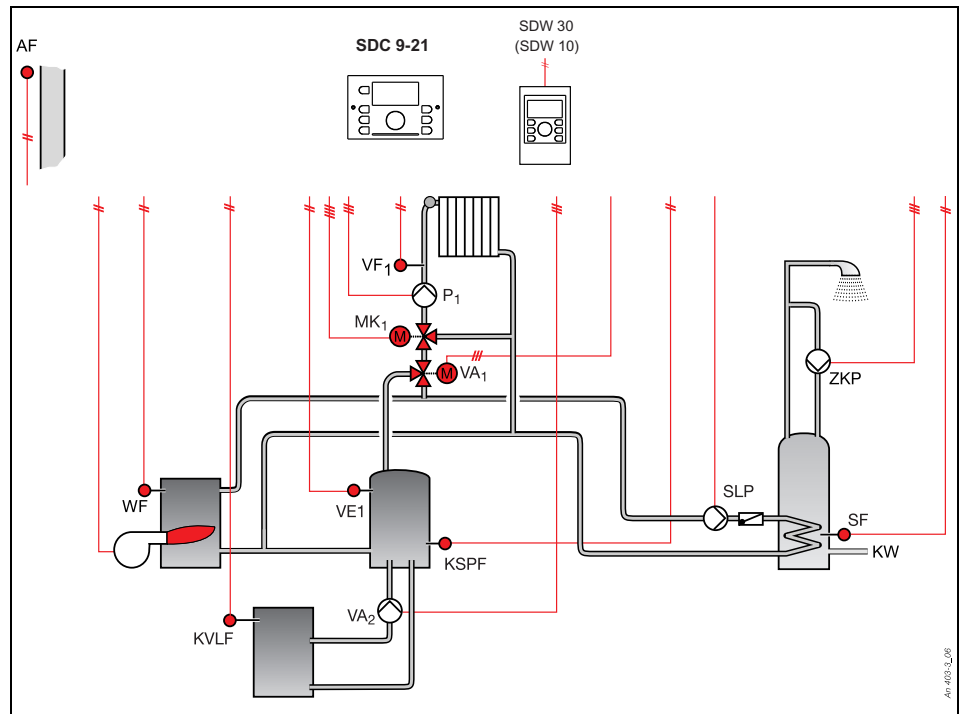

X 1		X 2		X 3		X 4	
23	GND	19		1	T2	10	VA1
24	BUS A	20		2	T1	11	VA2
25	BUS B	21	N	3	ZKP	12	L1
26	AF	22	L1	4		13	
27	WF			5	SLP	14	
28	SF			6	L 1	15	
29	VF1			7	MK1	16	
30	VE1			8	MK1	17	
31				9	P1	18	
32							
33							
34	KVLf						
35	KSPF						
36							
37							
38							

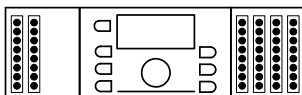

X 5		X 6		X 7		X 8		X 9		X 10	
1	Bus B	1	Bus A	1	T1	1	T2	1	N	1	PE
2	GND	2	AF	2		2	ZKP	2	N	2	PE
3	GND	3	WF	3		3	SLP	3	N	3	PE
4	GND	4	SF	4		4	MK1▲	4	N	4	PE
5	GND	5	VF 1	5	L 1	5	MK1▼	5	N	5	PE
6	GND	6	VE1	6		6	P 1	6	N	6	PE
7	GND	7		7		7	VA1	7	N	7	PE
8	GND	8		8		8	VA2	8	N	8	PE
9	GND	9		9		9		9	N	9	PE
10	GND	10	KVLf	10		10		10	N	10	PE
11	GND	11	KSPF	11		11		11	N	11	PE
12	GND	12						12	N	12	PE
								13	N	13	PE

**HINWEIS** Parametereingabe siehe 10.9.1 S. 61.  
**NOTE** For parameter entry, see 10.9.1 pg. 61.

### 10.9.1 Parametereingabe Hydraulik 0403 (SDC 9-21) Parameter entry of hydraulics 0403 (SDC 9-21)

#### Menü "Hydraulik" / "Hydraulics" menu

Parameter Parameter	Einstellwert Set value	Bemerkung	Remark
01	0000	Keine Einstellung	No setting
02	1	Warmwasserladepumpe	Hot-water charging pump
03	3	Mischheizkreis witterungsgeführt	Mixed heating circuit controlled by weather conditions
04	–	Nicht vorhanden	Not available
05	4	Zirkulationspumpe	Circulating pump
06	16	Pufferladepumpe	Buffer charging pump
07	15	Solarladepumpe	Solar charging pump
08	4	Pufferfühler 2	Buffer sensor 2
09 ...11	AUS / OFF	Keine Funktion	No function

#### Menü "Puffer" / "Buffer" menu

Parameter Parameter	Einstellwert Set value	Bemerkung	Remark
05	2	Zwangsabführung in Heizkreis	Forced discharge in heating circuit
10	4	Entladeregelung Heizkreis ohne Warmwasserkreis	Heating circuit discharge regulation without hot-water circuit

10.10 Hydraulik 0404 (SDC 9-21) / Hydraulics 0404 (SDC 9-21)

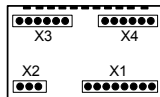
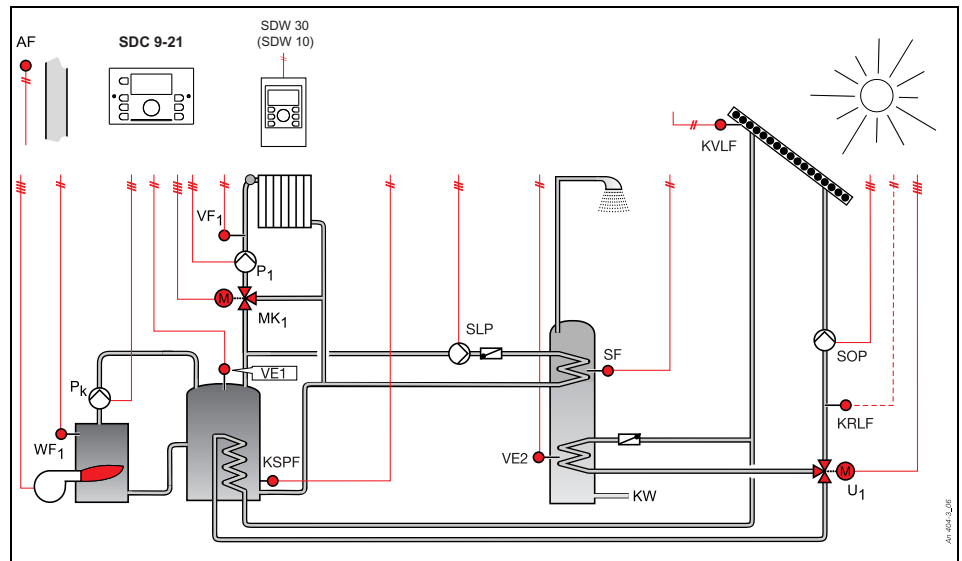

X 1		X 2		X 3		X 4	
23	GND	19		1	T2	10	PK
24	BUS A	20		2	T1	11	U1
25	BUS B	21	N	3	SOP	12	L1
26	AF	22	L1	4		13	
27	WF			5	SLP	14	
28	SF			6	L 1	15	
29	VF1			7	MK1▲	16	
30	VE1			8	MK1▼	17	
31	VE2			9	P1	18	
32	KRLF						
33							
34	KVLf						
35	KSPF						
36							
37							
38							

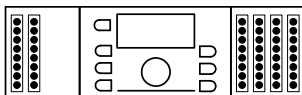

X 5		X 6		X 7		X 8		X 9		X 10	
1	Bus B	1	Bus A	1	T1	1	T2	1	N	1	PE
2	GND	2	AF	2		2	SOP	2	N	2	PE
3	GND	3	WF	3		3	SLP	3	N	3	PE
4	GND	4	SF	4		4	MK1▲	4	N	4	PE
5	GND	5	VF 1	5	L 1	5	MK1▼	5	N	5	PE
6	GND	6	VE1	6		6	P 1	6	N	6	PE
7	GND	7	VE2	7		7	PK	7	N	7	PE
8	GND	8	KRLF	8		8	U1	8	N	8	PE
9	GND	9		9		9		9	N	9	PE
10	GND	10	KVLf	10		10		10	N	10	PE
11	GND	11	KSPF	11		11		11	N	11	PE
12	GND	12						12	N	12	PE
								13	N	13	PE

**HINWEIS** Parametereingabe siehe 10.10.1 S. 63.

**NOTE** For parameter entry, see 10.10.1 pg. 63.

**10.10.1 Parametereingabe Hydraulik 0404 (SDC 9-21)**  
**Parameter entry of hydraulics 0404 (SDC 9-21)**

**Menü "Hydraulik" / "Hydraulics" menu**

<b>Parameter Parameter</b>	<b>Einstellwert Set value</b>	<b>Bemerkung</b>	<b>Remark</b>
01	0000	Keine Einstellung	No setting
02	1	Warmwasserladepumpe	Hot-water charging pump
03	3	Mischheizkreis witterungsgeführt	Mixed heating circuit controlled by weather conditions
04	–	Nicht vorhanden	Not available
05	15	Solarladepumpe	Solar charging pump
06	16	Pufferladepumpe	Buffer charging pump
07	19	Solarladeumschaltung U1	Solar charging switchover U1
08	–	Nicht vorhanden, definiert durch variablen Ausgang 1	Not available, defined via variable output 1
09	–	Nicht vorhanden, definiert durch variablen Ausgang 2	Not available, defined via variable output 2
10	14	Kollektorrücklauffühler	Collector return sensor
11	AUS / OFF	Keine Funktion	No function

10.11 Hydraulik 0405 (SDC 12-31) / Hydraulics 0405 (SDC 12-31)

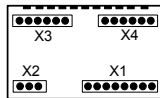
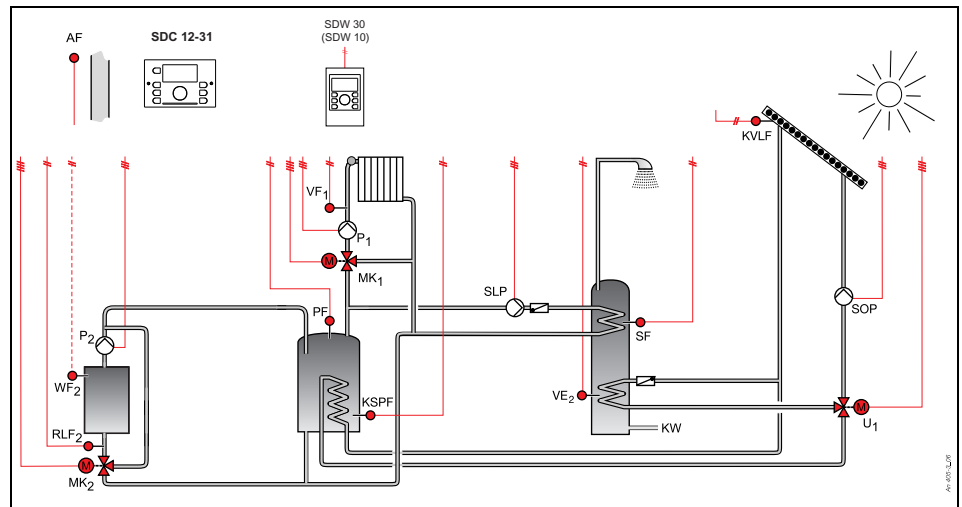

X 1		X 2		X 3		X 4	
23	GND	19	///	1	T2	10	P2
24	BUS A	20	///	2	T1	11	U1
25	BUS B	21	N	3	SOP	12	L1
26	AF	22	L1	4	///	13	MK2 ▲
27				5	SLP	14	MK2 ▼
28	SF			6	L 1	15	
29	VF1			7	MK1 ▲	16	
30	WF2			8	MK1 ▼	17	
31	VE2			9	P1	18	
32	PF						
33	RLF2						
34	KVLf						
35	KSPF						
36							
37	///						
38	///						

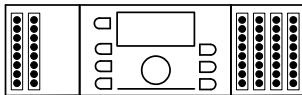

X 5		X 6		X 7		X 8		X 9		X 10	
1	Bus B	1	Bus A	1	T1	1	T2	1	N	1	PE
2	GND	2	AF	2		2	SOP	2	N	2	PE
3	GND	3		3		3	SLP	3	N	3	PE
4	GND	4	SF	4		4	MK1 ▲	4	N	4	PE
5	GND	5	VF 1	5	L 1	5	MK1 ▼	5	N	5	PE
6	GND	6	WF2	6		6	P 1	6	N	6	PE
7	GND	7	VE2	7		7	P2	7	N	7	PE
8	GND	8	PF	8		8	U1	8	N	8	PE
9	GND	9	RLF2	9		9	MK2 ▲	9	N	9	PE
10	GND	10	KVLf	10		10	MK2 ▼	10	N	10	PE
11	GND	11	KSPF	11				11	N	11	PE
12	GND	12						12	N	12	PE
								13	N	13	PE

**HINWEIS** Parametereingabe siehe 10.11.1 S. 65.

**NOTE** For parameter entry, see 10.11.1 pg. 65.



**10.11.1 Parametereingabe Hydraulik 0405 (SDC 12-31)  
Parameter entry of hydraulics 0405 (SDC 12-31)**

**Menü "Hydraulik" / "Hydraulics" menu**

<b>Parameter Parameter</b>	<b>Einstellwert / Set value</b>	<b>Bemerkung</b>	<b>Remark</b>
01	0000	Keine Einstellung	No setting
02	1	Warmwasserladepumpe	Hot-water charging pump
03	3	Mischheizkreis witterungsgeführt	Mixed heating circuit controlled by weather conditions
04	8	Rücklaufhochhaltung	Return maintenance
05	15	Solarladepumpe	Solar charging pump
06	17	Festbrennstoffladepumpe	Solid fuel charging pump
07	19	Solarladeumschaltung U1	Solar charging switchover U1
08	–	Nicht vorhanden, definiert durch variablen Ausgang 1	Not available, defined via variable output 1
09	–	Nicht vorhanden, definiert durch variablen Ausgang 2	Not available, defined via variable output 2
10	18	Feststoffpufferfühler	Solid buffer sensor
11	AUS / OFF	Keine Funktion	No function

10.12 Hydraulik 0406 (SDC 7-21) / Hydraulics 0406 (SDC 7-21)

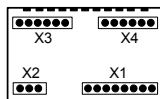
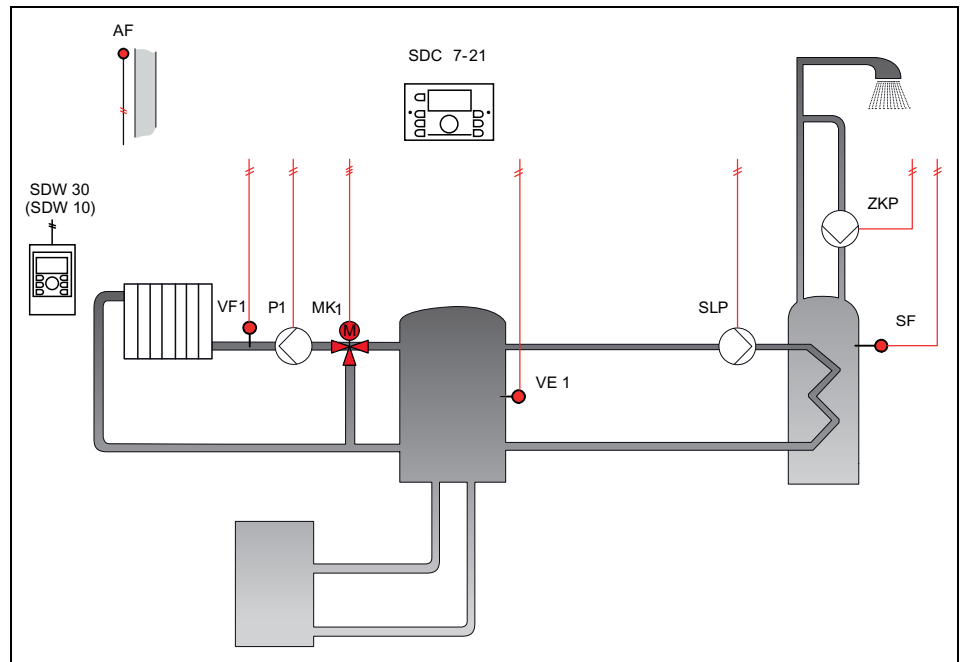

X 1		X 2		X 3		X 4	
23	GND	19	///	1		10	
24	BUS A	20	///	2		11	
25	BUS B	21	N	3	ZKP	12	
26	AF	22	L1	4	///	13	
27				5	SLP	14	
28	SF			6	L 1	15	
29	VF1			7	MK1▲	16	
30	VE1			8	MK1▼	17	
31				9	P1	18	
32							
33							
34							
35							
36							
37	///						
38	///						

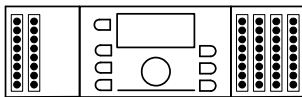

X 5		X 6		X 7		X 8		X 9		X 10	
1	Bus B	1	Bus A	1		1		1	N	1	PE
2	GND	2	AF	2		2	DKP	2	N	2	PE
3	GND	3		3		3	SLP	3	N	3	PE
4	GND	4	SF	4		4	MK1▲	4	N	4	PE
5	GND	5	VF 1	5	L 1	5	MK1▼	5	N	5	PE
6	GND	6	VE1	6		6	P 1	6	N	6	PE
7	GND	7		7		7		7	N	7	PE
8	GND	8		8		8		8	N	8	PE
9	GND	9		9		9		9	N	9	PE
10	GND	10		10		10		10	N	10	PE
11	GND	11		11		11		11	N	11	PE
12	GND	12						12	N	12	PE
								13	N	13	PE

**HINWEIS** Parametereingabe siehe 10.12.1 S. 67.

**NOTE** For parameter entry, see 10.12.1 pg. 67.

**10.12.1 Parametereingabe Hydraulik 0406 (SDC 7-21)  
Parameter entry of hydraulics 0406 (SDC 7-21)**

**Menü "Hydraulik" / "Hydraulics" menu**

<b>Parameter Parameter</b>	<b>Einstellwert Set value</b>	<b>Bemerkung</b>	<b>Remark</b>
01	0000	Keine Einstellung	No setting
02	1	Warmwasserladepumpe	Hot-water charging pump
03	3	Mischheizkreis witterungsgeführt	Mixed heating circuit controlled by weather conditions
05	4	Zirkulationspumpe	Circulating pump
08	19	Pufferfühler 1	Buffer sensor 1

**Menü "Warmwasserkreis" / "Hot-water circuit" menu**

<b>Parameter Parameter</b>	<b>Einstellwert Set value</b>	<b>Bemerkung</b>	<b>Remark</b>
07	1	Parallelbetrieb	Parallel operation

**Menü "Puffer" / "Buffer" menu**

<b>Parameter Parameter</b>	<b>Einstellwert Set value</b>	<b>Bemerkung</b>	<b>Remark</b>
05	2	Zwangsabführung in Heizkreise	Forced discharge in heating circuits

**Menü "Mischheizkreis 1" / "Mixed heating circuit 1" menu**

<b>Parameter Parameter</b>	<b>Einstellwert Set value</b>	<b>Bemerkung</b>	<b>Remark</b>
Heizkurve Heating curve	1	Steilheit	Slope
Reduziert Reduced	ABS / RED	Reduzierter Betrieb ABS Absenkbetrieb ECO Abschaltbetrieb	Reduced operation RED Lowering operation ECO Switch-off operation
Heiz- system Heating system	FBH / UFH RAD / RAD KONV / CONV	FBH Fußbodenheizung RAD Radiator KONV Konvektor	UFH Floor heating RAD Radiator CONV Convector heater
13	45/75/80 °C	Maximaltemperatur- begrenzung	Maximum temperature limit
21	120	Laufzeit Stellantrieb	Actuator runtime

**Menü "Wärmeerzeuger" / "Heat generator" menu**

<b>Parameter Parameter</b>	<b>Einstellwert Set value</b>	<b>Bemerkung</b>	<b>Remark</b>
01	AUS / OFF	Ausführung AUS Ohne Wärmeerzeuger 1 Öl / Gas einstufig 2 Öl / Gas zweistufig 3 Öl / Gas 2 x einstufig 4 Modulierender Brenner 5 Open Therm	Design OFF Without heat generator 1 Oil / gas - one stage 2 Oil / gas - two stages 3 Oil / gas - 2 x one stage 4 Modulating burner 5 Open Therm

10.13 Hydraulik 0407 (SDC 9-21) / Hydraulics 0407 (SDC 9-21)

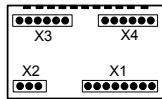
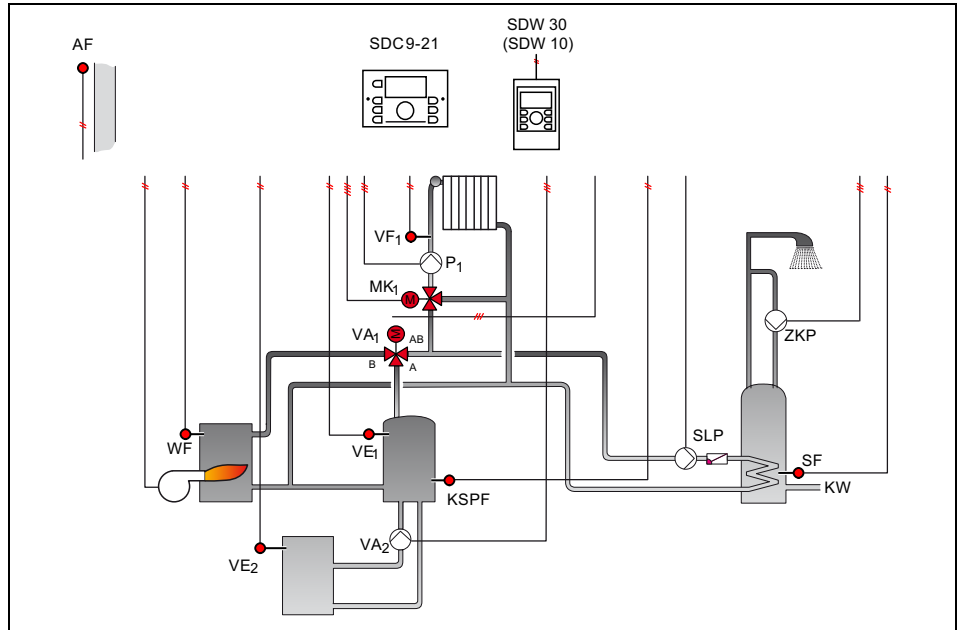

X 1		X 2		X 3		X 4	
23	GND	19	///	1	T2	10	VA1
24	BUS A	20	///	2	T1	11	VA2
25	BUS B	21	N	3	ZKP	12	L1
26	AF	22	L1	4	///	13	
27	WF			5	SLP	14	
28	SF			6	L 1	15	
29	VF1			7	MK1 ▲	16	
30	VE1			8	MK1 ▼	17	
31	VE2			9	P1	18	
32							
33							
34							
35	KSPF						
36							
37	///						
38	///						

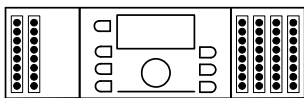

X 5		X 6		X 7		X 8		X 9		X 10	
1	Bus B	1	Bus A	1	T1	1	T2	1	N	1	PE
2	GND	2	AF	2		2	ZKP	2	N	2	PE
3	GND	3	WF	3		3	SLP	3	N	3	PE
4	GND	4	SF	4		4	MK1 ▲	4	N	4	PE
5	GND	5	VF 1	5	L 1	5	MK1 ▼	5	N	5	PE
6	GND	6	VE1	6		6	P 1	6	N	6	PE
7	GND	7	VE2	7		7	VA1	7	N	7	PE
8	GND	8		8		8	VA2	8	N	8	PE
9	GND	9		9		9		9	N	9	PE
10	GND	10		10		10		10	N	10	PE
11	GND	11	KSPF	11		11		11	N	11	PE
12	GND	12						12	N	12	PE
								13	N	13	PE

**HINWEIS** Parametereingabe siehe 10.13.1 S. 70.

**NOTE** For parameter entry, see 10.13.1 pg. 70.

### 10.13.1 Parametereingabe Hydraulik 0407 (SDC 9-21) Parameter entry of hydraulics 0407 (SDC 9-21)

#### Menü "Hydraulik" / "Hydraulics" menu

Parameter Parameter	Einstellwert Set value	Bemerkung	Remark
01	0000	Keine Einstellung	No setting
02	1	Warmwasserladepumpe	Hot-water charging pump
03	3	Mischheizkreis witterungsgeführt	Mixed heating circuit controlled by weather conditions
05	4	Zirkulationspumpe	Circulating pump
06	16	Pufferladepumpe	Buffer charging pump
07	17	Festbrennstoffladepumpe	Solid fuel charging pump
04, 10, 11	AUS / OFF	Keine Funktion	No function

#### Menü "Warmwasserkreis" / "Hot-water circuit" menu

Parameter Parameter	Einstellwert Set value	Bemerkung	Remark
07	1	Parallelbetrieb	Parallel operation
08	AUS / OFF	Kein Speicherentlade- schutz	No tank discharge protection

#### Menü "Puffer" / "Buffer" menu

Parameter Parameter	Einstellwert Set value	Bemerkung	Remark
05	2	Zwangsabführung in Heizkreise	Forced discharge in heating circuits
10	3	Entladeregelung Heizkreis und Warmwasserkreis	Heating circuit and hot-water circuit discharge regulation

## Menü "Mischheizkreis 1" / "Mixed heating circuit 1" menu

<b>Parameter Parameter</b>	<b>Einstellwert Set value</b>	<b>Bemerkung</b>	<b>Remark</b>
Heizkurve Heating curve	1	Steilheit	Slope
Reduziert Reduced	ABS / RED	Reduzierter Betrieb ABS Absenkbetrieb ECO Abschaltbetrieb	Reduced operation RED Lowering operation ECO Switch-off operation
Heiz- system Heating system	FBH / UFH RAD / RAD KONV / CONV	FBH Fußbodenheizung RAD Radiator KONV Konvektor	UFH Floor heating RAD Radiator CONV Convector heater
13	45/75/80 °C	Maximaltemperatur- begrenzung	Maximum temperature limit
21	120	Laufzeit Stellantrieb	Actuator runtime

## 11 Fernheizungs-Applikationen / District heating applications

### 11.1 Übersicht / Overview

Hydraulik Hydraulics	Typ Type	Seite Page
0501	SDC 7-21* SDC 9-21*	73
0502	SDC 7-21* SDC 9-21*	74
0503	SDC 7-21* SDC 9-21*	75
0504	SDC 7-21* SDC 9-21*	76
0505	SDC 7-21* SDC 9-21*	77
0506	SDC 7-21* SDC 9-21*	78
0507	SDC 7-21* SDC 9-21*	79
0508	SDC 9-21*	80
0509	SDC 12-31*	81
0510	SDC 12-31*	82
0511	SDC 12-31*	83
0512	SDC 12-31*	84
0513	SDC 12-31*	85
0514	SDC 9-21*	86

\* DHC-Modus / DHC mode

**HINWEIS** STW = Sicherheitstemperaturwächter

**NOTE** STM = Safety temperature monitor



### 11.2 Hydraulik 0501 (SDC 7-21 / SDC 9-21, DHC-Modus) Hydraulics 0501 (SDC 7-21 / SDC 9-21, DHC mode)

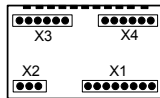
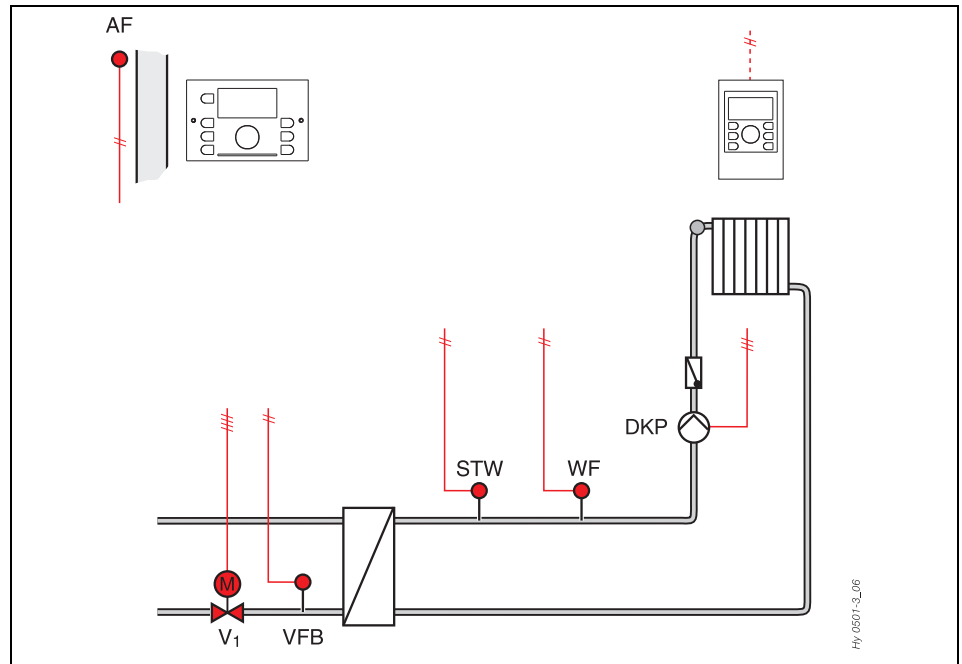

X 1		X 2		X 3		X 4	
23	GND	19		1	V 1 ▼	10	
24	BUS A	20		2	L 1	11	
25	BUS B	21	N	3	DKP	12	
26	AF	22	L 1	4		13	
27	WF			5		14	
28				6	L 1	15	
29				7		16	V 1 ▲
30				8		17	
31				9		18	L 1
32	VFB						
33							
34							
35							
36							
37							
38							

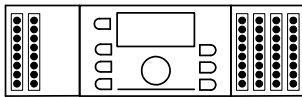

X 5		X 6		X 7		X 8		X 9		X 10	
1	Bus B	1	Bus A	1		1	V 1 ▼	1	N	1	PE
2	GND	2	AF	2		2	DKP	2	N	2	PE
3	GND	3	WF	3		3		3	N	3	PE
4	GND	4		4		4		4	N	4	PE
5	GND	5		5	L 1	5		5	N	5	PE
6	GND	6		6		6		6	N	6	PE
7	GND	7		7		7		7	N	7	PE
8	GND	8	VFB	8		8		8	N	8	PE
9	GND	9		9		9		9	N	9	PE
10	GND	10		10		10		10	N	10	PE
11	GND	11		11	V 1 ▲	11		11	N	11	PE
12	GND	12						12	N	12	PE
								13	N	13	PE

### 11.3 Hydraulik 0502 (SDC 7-21 / SDC 9-21, DHC-Modus) Hydraulics 0502 (SDC 7-21 / SDC 9-21, DHC mode)

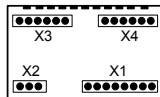
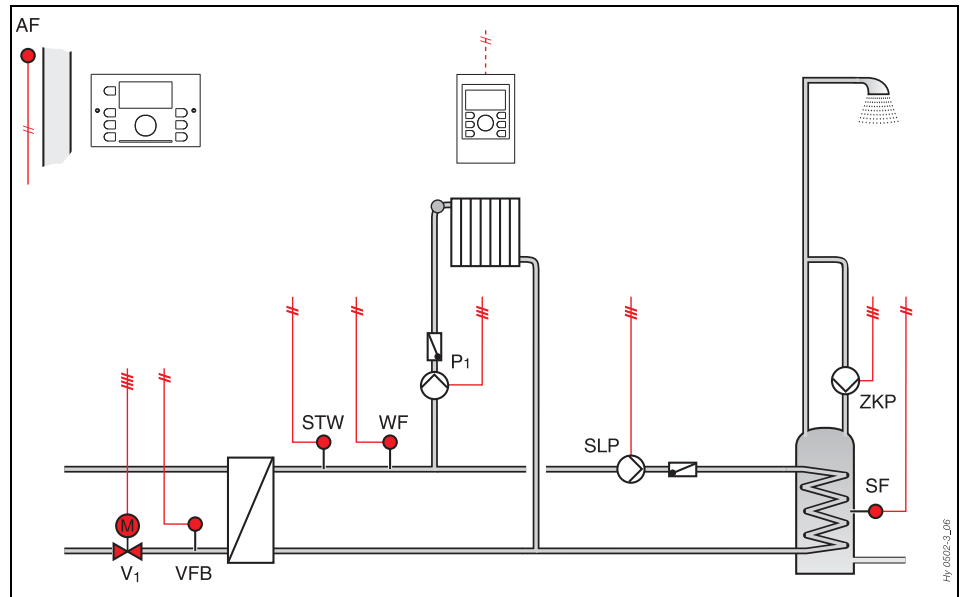

X 1		X 2		X 3		X 4	
23	GND	19		1	V 1 ▼	10	
24	BUS A	20		2	L 1	11	
25	BUS B	21	N	3	ZKP	12	
26	AF	22	L 1	4		13	
27	WF			5	SLP	14	
28	SF			6	L 1	15	
29				7		16	V 1 ▲
30				8		17	
31				9	P 1	18	L 1
32	VFB						
33							
34							
35							
36							
37							
38							

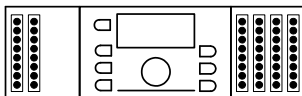

X 5		X 6		X 7		X 8		X 9		X 10	
1	Bus B	1	Bus A	1		1	V 1 ▼	1	N	1	PE
2	GND	2	AF	2		2	ZKP	2	N	2	PE
3	GND	3	WF	3		3	SLP	3	N	3	PE
4	GND	4	SF	4		4		4	N	4	PE
5	GND	5		5	L 1	5		5	N	5	PE
6	GND	6		6		6	P 1	6	N	6	PE
7	GND	7		7		7		7	N	7	PE
8	GND	8	VFB	8		8		8	N	8	PE
9	GND	9		9		9		9	N	9	PE
10	GND	10		10		10		10	N	10	PE
11	GND	11		11		11		11	N	11	PE
12	GND	12		12		12		12	N	12	PE
								13	N	13	PE

### 11.4 Hydraulik 0503 (SDC 7-21 / SDC 9-21, DHC-Modus) Hydraulics 0503 (SDC 7-21 / SDC 9-21, DHC mode)

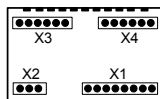
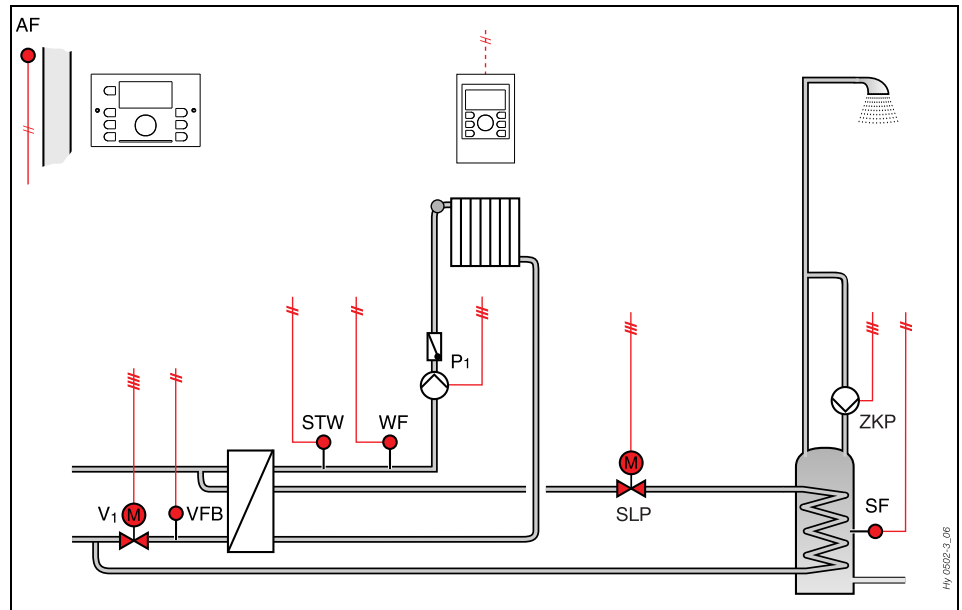

X 1		X 2		X 3		X 4	
23	GND	19		1	V 1 ▼	10	
24	BUS A	20		2	L 1	11	
25	BUS B	21	N	3	ZKP	12	
26	AF	22	L 1	4		13	
27	WF			5	SLP	14	
28	SF			6	L 1	15	
29				7		16	V 1 ▲
30				8		17	
31				9	P 1	18	L 1
32	VFB						
33							
34							
35							
36							
37							
38							

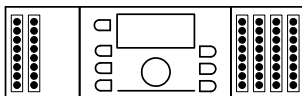

X 5		X 6		X 7		X 8		X 9		X 10	
1	Bus B	1	Bus A	1		1	V 1 ▼	1	N	1	PE
2	GND	2	AF	2		2	ZKP	2	N	2	PE
3	GND	3	WF	3		3	SLP	3	N	3	PE
4	GND	4	SF	4		4		4	N	4	PE
5	GND	5		5	L 1	5		5	N	5	PE
6	GND	6		6		6	P 1	6	N	6	PE
7	GND	7		7		7		7	N	7	PE
8	GND	8	VFB	8		8		8	N	8	PE
9	GND	9		9		9		9	N	9	PE
10	GND	10		10		10		10	N	10	PE
11	GND	11		11	V 1 ▲	11		11	N	11	PE
12	GND	12						12	N	12	PE
								13	N	13	PE

### 11.5 Hydraulik 0504 (SDC 7-21 / SDC 9-21, DHC-Modus) Hydraulics 0504 (SDC 7-21 / SDC 9-21, DHC mode)

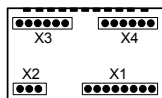
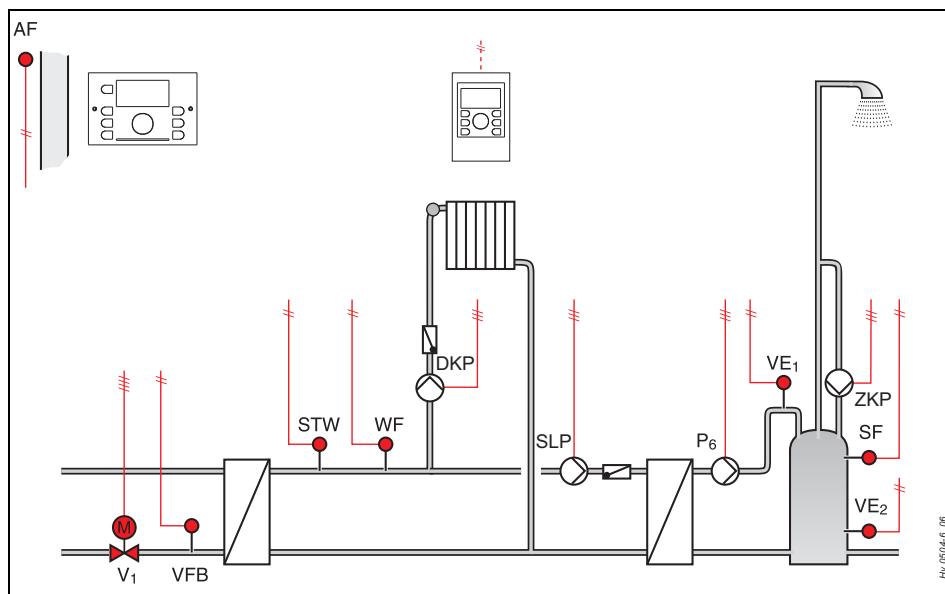

X 1		X 2		X 3		X 4	
23	GND	19		1	V 1 ▼	10	P 6
24	BUS A	20		2	L 1	11	ZKP
25	BUS B	21	N	3	DKP	12	L 1
26	AF	22	L 1	4		13	
27	WF			5	SLP	14	
28	SF			6	L 1	15	
29				7		16	V 1 ▲
30	VE 2			8		17	
31	VE 1			9		18	L 1
32	VFB						
33							
34							
35							
36							
37							
38							

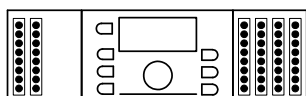

X 5		X 6		X 7		X 8		X 9		X 10	
1	Bus B	1	Bus A	1		1	V 1 ▼	1	N	1	PE
2	GND	2	AF	2		2	DKP	2	N	2	PE
3	GND	3	WF	3		3	SLP	3	N	3	PE
4	GND	4	SF	4		4		4	N	4	PE
5	GND	5		5	L 1	5		5	N	5	PE
6	GND	6	VE 2	6		6		6	N	6	PE
7	GND	7	VE 1	7		7	ZKP	7	N	7	PE
8	GND	8	VFB	8		8	P 6	8	N	8	PE
9	GND	9		9		9		9	N	9	PE
10	GND	10		10		10		10	N	10	PE
11	GND	11		11		11		11	N	11	PE
12	GND	12						12	N	12	PE
								13	N	13	PE

### 11.6 Hydraulik 0505 (SDC 7-21 / SDC 9-21, DHC-Modus) Hydraulics 0505 (SDC 7-21 / SDC 9-21, DHC mode)

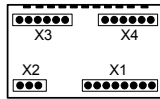
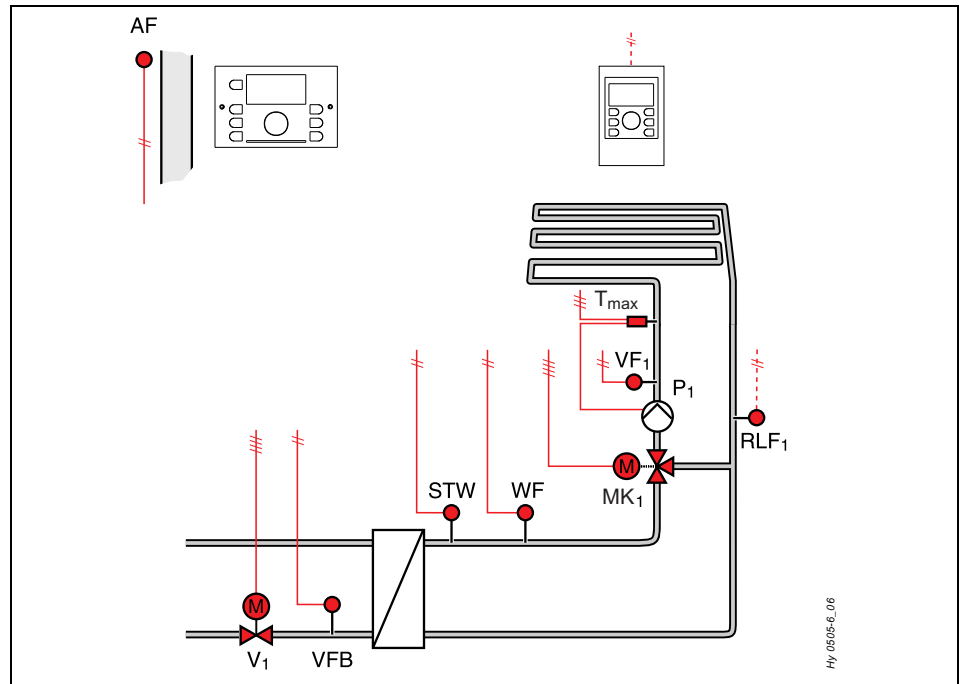

X 1		X 2		X 3		X 4	
23	GND	19		1	V 1 ▼	10	
24	BUS A	20		2	L 1	11	
25	BUS B	21	N	3		12	
26	AF	22	L 1	4		13	
27	WF			5		14	
28				6	L 1	15	
29	VF 1			7	MK1 ▲	16	V 1 ▲
30	RLF 1			8	MK1 ▼	17	
31				9	P 1	18	L 1
32	VFB						
33							
34							
35							
36							
37							
38							

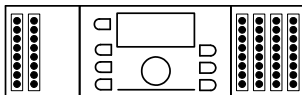

X 5		X 6		X 7		X 8		X 9		X 10	
1	Bus B	1	Bus A	1		1	V 1 ▼	1	N	1	PE
2	GND	2	AF	2		2		2	N	2	PE
3	GND	3	WF	3		3		3	N	3	PE
4	GND	4		4		4	MK1 ▲	4	N	4	PE
5	GND	5	VF 1	5	L 1	5	MK1 ▼	5	N	5	PE
6	GND	6	RLF 1	6		6	P 1	6	N	6	PE
7	GND	7		7		7		7	N	7	PE
8	GND	8	VFB	8		8		8	N	8	PE
9	GND	9		9		9		9	N	9	PE
10	GND	10		10		10		10	N	10	PE
11	GND	11		11	V 1 ▲	11		11	N	11	PE
12	GND	12						12	N	12	PE
								13	N	13	PE

### 11.7 Hydraulik 0506 (SDC 7-21 / SDC 9-21, DHC-Modus) Hydraulics 0506 (SDC 7-21 / SDC 9-21, DHC mode)

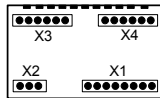
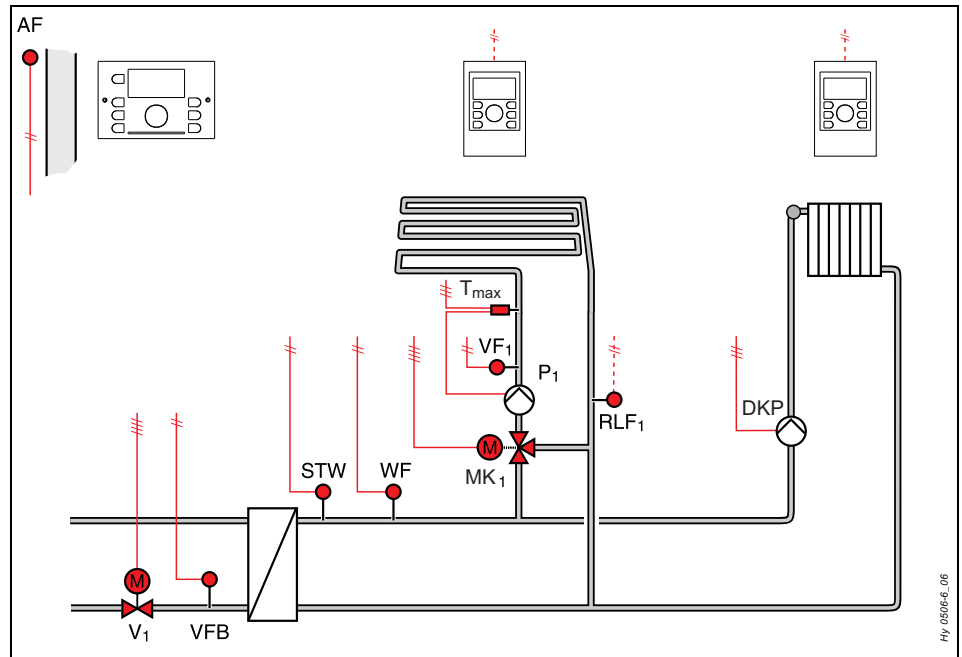

X 1		X 2		X 3		X 4	
23	GND	19		1	V 1 ▼	10	
24	BUS A	20		2	L 1	11	
25	BUS B	21	N	3	DKP	12	
26	AF	22	L 1	4		13	
27	WF			5		14	
28				6	L 1	15	
29	VF 1			7	MK1 ▲	16	V 1 ▲
30	RLF 1			8	MK1 ▼	17	
31				9	P 1	18	L 1
32	VFB						
33							
34							
35							
36							
37							
38							

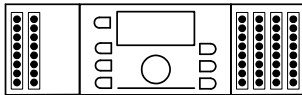

X 5		X 6		X 7		X 8		X 9		X 10	
1	Bus B	1	Bus A	1		1	V 1 ▼	1	N	1	PE
2	GND	2	AF	2		2	DKP	2	N	2	PE
3	GND	3	WF	3		3		3	N	3	PE
4	GND	4		4		4	MK1 ▲	4	N	4	PE
5	GND	5	VF 1	5	L 1	5	MK1 ▼	5	N	5	PE
6	GND	6	RLF 1	6		6	P 1	6	N	6	PE
7	GND	7		7		7		7	N	7	PE
8	GND	8	VFB	8		8		8	N	8	PE
9	GND	9		9		9		9	N	9	PE
10	GND	10		10		10		10	N	10	PE
11	GND	11		11	V 1 ▲	11		11	N	11	PE
12	GND	12						12	N	12	PE
								13	N	13	PE

**11.8 Hydraulik 0507 (SDC 7-21 / SDC 9-21, DHC-Modus)  
Hydraulics 0507 (SDC 7-21 / SDC 9-21, DHC mode)**

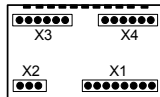
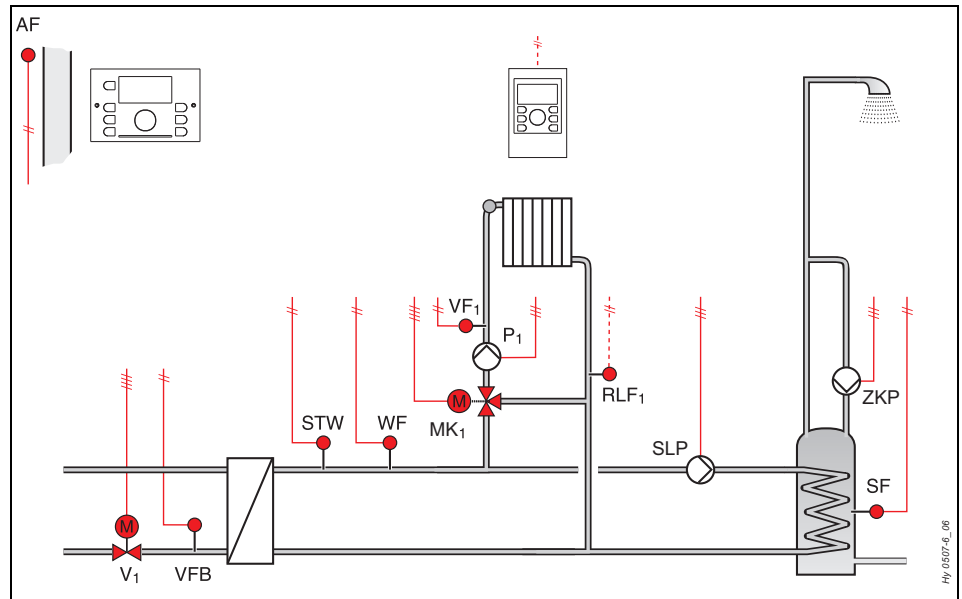

X 1		X 2		X 3		X 4	
23	GND	19		1	V 1 ▼	10	
24	BUS A	20		2	L 1	11	
25	BUS B	21	N	3	ZKP	12	
26	AF	22	L 1	4		13	
27	WF			5	SLP	14	
28	SF			6	L 1	15	
29	VF 1			7	MK1 ▲	16	V 1 ▲
30	RLF 1			8	MK1 ▼	17	
31				9	P 1	18	L 1
32	VFB						
33							
34							
35							
36							
37							
38							

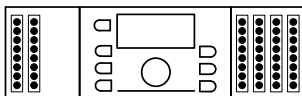

X 5		X 6		X 7		X 8		X 9		X 10	
1	Bus B	1	Bus A	1		1	V 1 ▼	1	N	1	PE
2	GND	2	AF	2		2	ZKP	2	N	2	PE
3	GND	3	WF	3		3	SLP	3	N	3	PE
4	GND	4	SF	4		4	MK1 ▲	4	N	4	PE
5	GND	5	VF 1	5	L 1	5	MK1 ▼	5	N	5	PE
6	GND	6	RLF 1	6		6	P 1	6	N	6	PE
7	GND	7	VFB	7		7		7	N	7	PE
8	GND	8		8		8		8	N	8	PE
9	GND	9		9		9		9	N	9	PE
10	GND	10		10		10		10	N	10	PE
11	GND	11		11	V 1 ▲	11		11	N	11	PE
12	GND	12						12	N	12	PE
								13	N	13	PE

### 11.9 Hydraulik 0508 (SDC 9-21, DHC-Modus) Hydraulics 0508 (SDC 9-21, DHC mode)

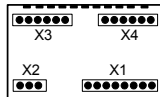
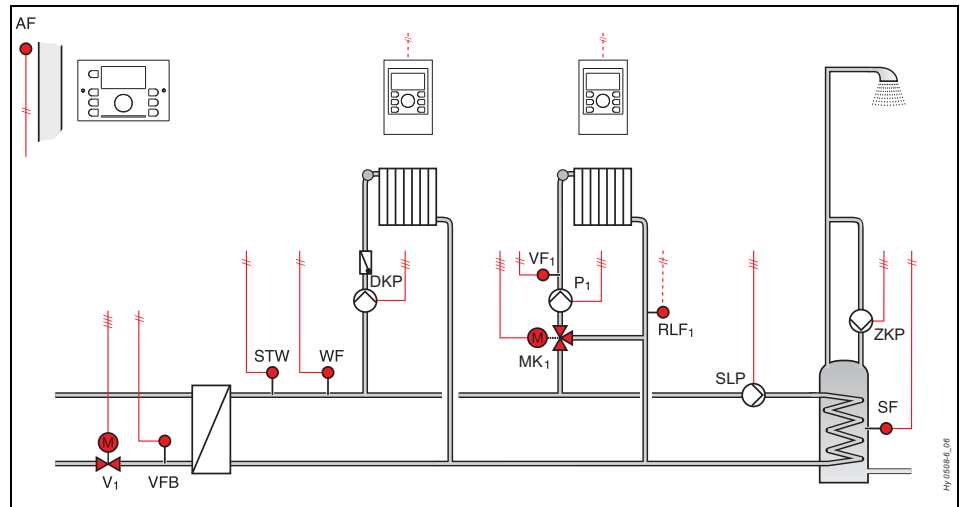

X 1		X 2		X 3		X 4	
23	GND	19		1	V 1 ▼	10	ZKP
24	BUS A	20		2	L 1	11	
25	BUS B	21	N	3	DKP	12	L 1
26	AF	22	L 1	4		13	
27	WF			5	SLP	14	
28	SF			6	L 1	15	
29	VF 1			7	MK1 ▲	16	V 1 ▲
30	RLF 1			8	MK1 ▼	17	
31				9	P 1	18	L 1
32	VFB						
33							
34							
35							
36							
37							
38							

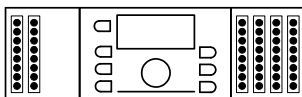

X 5		X 6		X 7		X 8		X 9		X 10	
1	Bus B	1	Bus A	1		1	V 1 ▼	1	N	1	PE
2	GND	2	AF	2		2	DKP	2	N	2	PE
3	GND	3	WF	3		3	SLP	3	N	3	PE
4	GND	4	SF	4		4	MK1 ▲	4	N	4	PE
5	GND	5	VF 1	5	L 1	5	MK1 ▼	5	N	5	PE
6	GND	6	RLF 1	6		6	P 1	6	N	6	PE
7	GND	7	VFB	7		7	ZKP	7	N	7	PE
8	GND	8		8		8		8	N	8	PE
9	GND	9		9		9		9	N	9	PE
10	GND	10		10		10		10	N	10	PE
11	GND	11		11	V 1 ▲	11		11	N	11	PE
12	GND	12						12	N	12	PE
								13	N	13	PE



### 11.10 Hydraulik 0509 (SDC 12-31, DHC-Modus) Hydraulics 0509 (SDC 12-31, DHC mode)

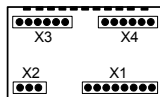
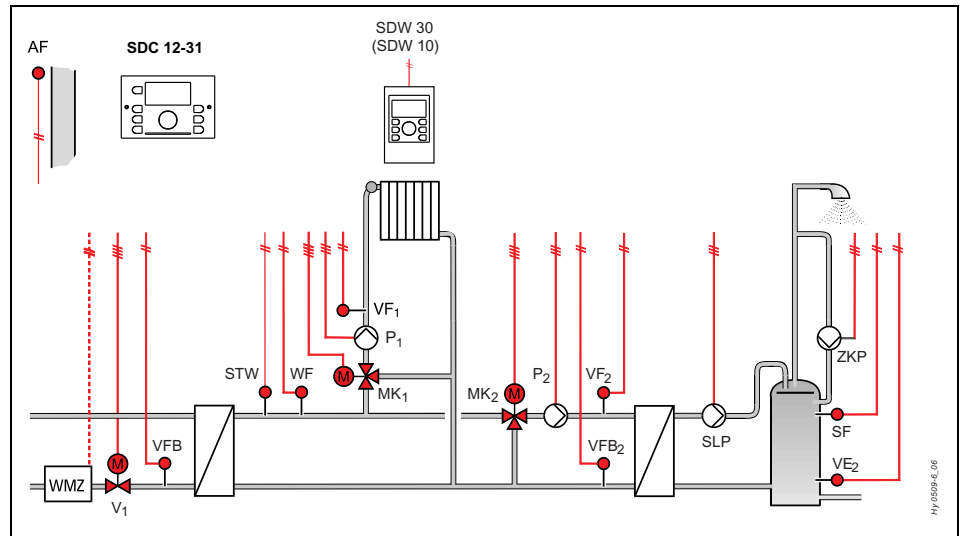

X 1		X 2		X 3		X 4	
23	GND	19		1	V 1 ▼	10	ZKP
24	BUS A	20		2	L 1	11	
25	BUS B	21	N	3		12	L 1
26	AF	22	L 1	4		13	MK2▲
27	WF			5	SLP	14	MK2▼
28	SF			6	L 1	15	P 2
29	VF 1			7	MK1▲	16	V 1 ▲
30	VFB2			8	MK1▼	17	
31	VE2			9	P 1	18	L 1
32	VFB						
33	VF2						
34							
35							
36							
37							
38							

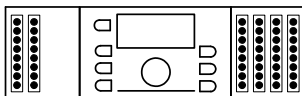

X 5		X 6		X 7		X 8		X 9		X 10	
1	Bus B	1	Bus A	1		1	V 1 ▼	1	N	1	PE
2	GND	2	AF	2		2		2	N	2	PE
3	GND	3	WF	3		3	SLP	3	N	3	PE
4	GND	4	SF	4		4	MK1▲	4	N	4	PE
5	GND	5	VF 1	5	L 1	5	MK1▼	5	N	5	PE
6	GND	6	VFB2	6		6	P 1	6	N	6	PE
7	GND	7	VE2	7		7	ZKP	7	N	7	PE
8	GND	8	VFB	8		8		8	N	8	PE
9	GND	9	VF2	9		9	MK2▲	9	N	9	PE
10	GND	10		10		10	MK2▼	10	N	10	PE
11	GND	11		11	V 1 ▲	11	P 2	11	N	11	PE
12	GND	12						12	N	12	PE
								13	N	13	PE

### 11.11 Hydraulik 0510 (SDC 12-31, DHC-Modus) Hydraulics 0510 (SDC 12-31, DHC mode)

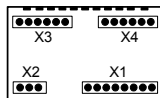
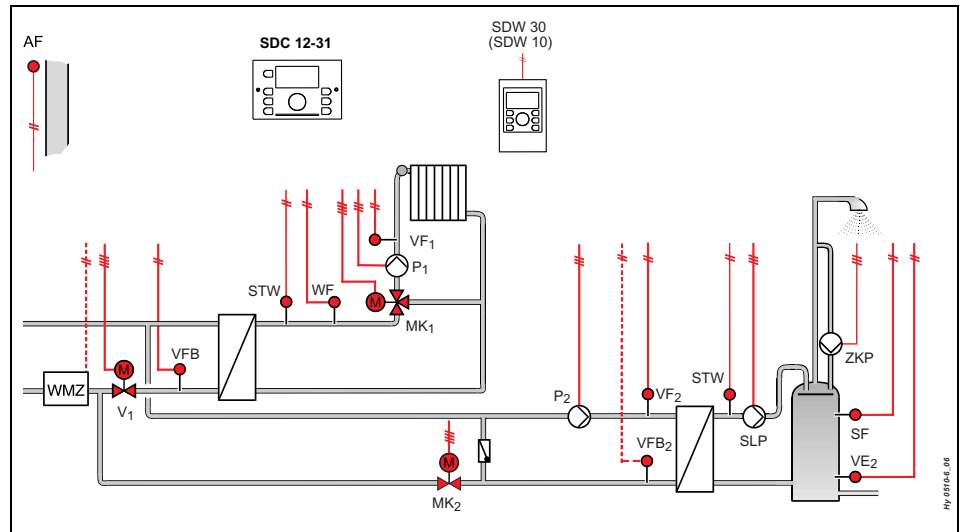

X 1		X 2		X 3		X 4	
23	GND	19		1	V 1 ▼	10	ZKP
24	BUS A	20		2	L 1	11	
25	BUS B	21	N	3		12	L 1
26	AF	22	L 1	4		13	MK2▲
27	WF			5	SLP	14	MK2▼
28	SF			6	L 1	15	P2
29	VF 1			7	MK1▲	16	V 1 ▲
30	VFB2			8	MK1▼	17	
31	VE2			9	P 1	18	L 1
32	VFB						
33	VF2						
34							
35							
36							
37							
38							

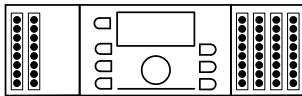

X 6		X 7		X 8		X 9		X 10	
1	Bus B	1	Bus A	1		1	V 1 ▼	1	PE
2	GND	2	AF	2		2		2	PE
3	GND	3	WF	3		3	SLP	3	PE
4	GND	4	SF	4		4	MK1 ▲	4	PE
5	GND	5	VF 1	5	L 1	5	MK1 ▼	5	PE
6	GND	6	VFB2	6		6	P 1	6	PE
7	GND	7	VE2	7		7	ZKP	7	PE
8	GND	8	VFB	8		8	P4	8	PE
9	GND	9	VF2	9		9	MK2 ▲	9	PE
10	GND	10		10		10	MK2 ▼	10	PE
11	GND	11		11	V 1 ▲	11	P2	11	PE
12	GND	12						12	PE
								13	PE

### 11.12 Hydraulik 0511 (SDC 12-31, DHC-Modus) Hydraulics 0511 (SDC 12-31, DHC mode)

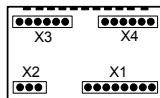
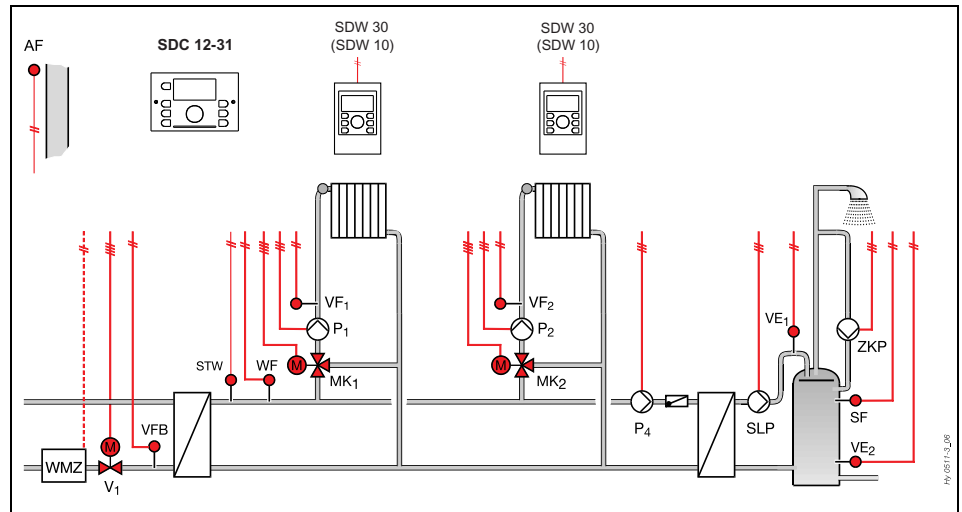

X 1		X 2		X 3		X 4	
23	GND	19		1	V 1 ▼	10	ZKP
24	BUS A	20		2	L 1	11	SLP
25	BUS B	21	N	3		12	L 1
26	AF	22	L 1	4		13	MK2 ▲
27	WF			5	P 4	14	MK2 ▼
28	SF			6	L 1	15	P 2
29	VF 1			7	MK1 ▲	16	V 1 ▲
30	VE1			8	MK1 ▼	17	
31	VE2			9	P 1	18	L 1
32	VFB						
33	VF2						
34							
35							
36							
37							
38							

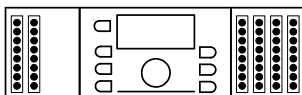

X 5		X 6		X 7		X 8		X 9		X 10	
1	Bus B	1	Bus A	1		1	V 1 ▼	1	N	1	PE
2	GND	2	AF	2		2	L 1	2	N	2	PE
3	GND	3	W	3		3	SLP	3	N	3	PE
4	GND	4	SF	4		4	MK1 ▲	4	N	4	PE
5	GND	5	VF 1	5	L 1	5	MK1 ▼	5	N	5	PE
6	GND	6	VE1	6		6	P 1	6	N	6	PE
7	GND	7	VE2	7		7	ZK	7	N	7	PE
8	GND	8	VFB	8		8	P 4	8	N	8	PE
9	GND	9	VF2	9		9	MK2 ▲	9	N	9	PE
10	GND	10		10		10	MK2 ▼	10	N	10	PE
11	GND	11		11	V 1 ▲	11	P 2	11	N	11	PE
12	GND	12						12	N	12	PE
								13	N	13	PE

### 11.13 Hydraulik 0512 (SDC 12-31, DHC-Modus) Hydraulics 0512 (SDC 12-31, DHC mode)

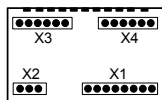
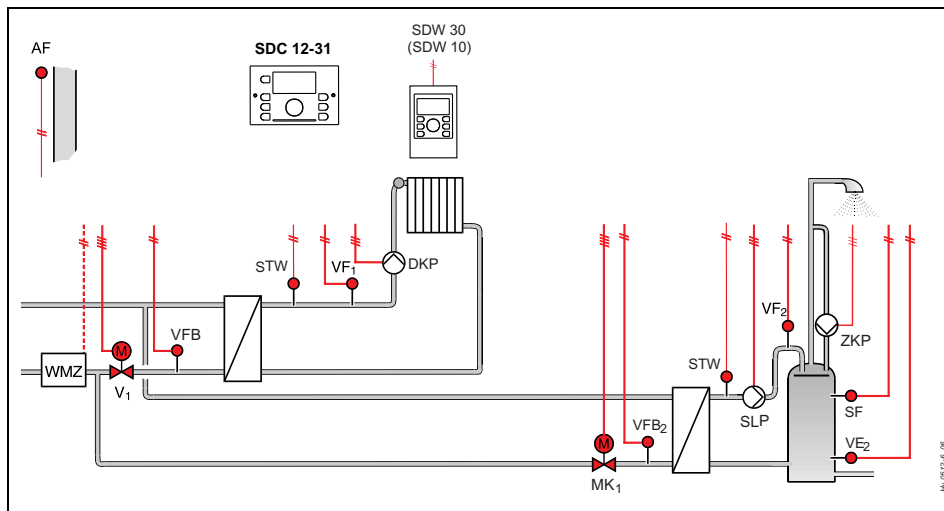

X 1		X 2		X 3		X 4	
23	GND	19		1	V1 ▼	10	ZKP
24	BUS A	20		2	L 1	11	
25	BUS B	21	N	3	DKP	12	L 1
26	AF	22	L 1	4		13	
27	VF1			5	SLP	14	
28	SF			6	L 1	15	
29	VF 2			7	MK1▲	16	V1 ▲
30	VFB2			8	MK1▼	17	
31	VE2			9		18	L 1
32	VFB						
33							
34							
35							
36							
37							
38							

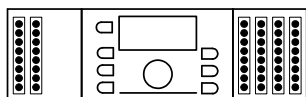

X 5		X 6		X 7		X 8		X 9		X 10	
1	Bus B	1	Bus A	1		1	V1 ▼	1	N	1	PE
2	GND	2	AF	2		2	DKP	2	N	2	PE
3	GND	3	VF1	3		3	SLP	3	N	3	PE
4	GND	4	SF	4		4	MK1▲	4	N	4	PE
5	GND	5	VF 2	5	L 1	5	MK1▼	5	N	5	PE
6	GND	6	VFB2	6		6		6	N	6	PE
7	GND	7	VE2	7		7	ZKP	7	N	7	PE
8	GND	8	VFB	8		8		8	N	8	PE
9	GND	9		9		9		9	N	9	PE
10	GND	10		10		10		10	N	10	PE
11	GND	11		11	V1 ▲	11		11	N	11	PE
12	GND	12						12	N	12	PE
								13	N	13	PE

### 11.14 Hydraulik 0513 (SDC 12-31, DHC-Modus) Hydraulics 0513 (SDC 12-31, DHC mode)

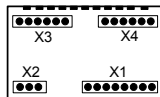
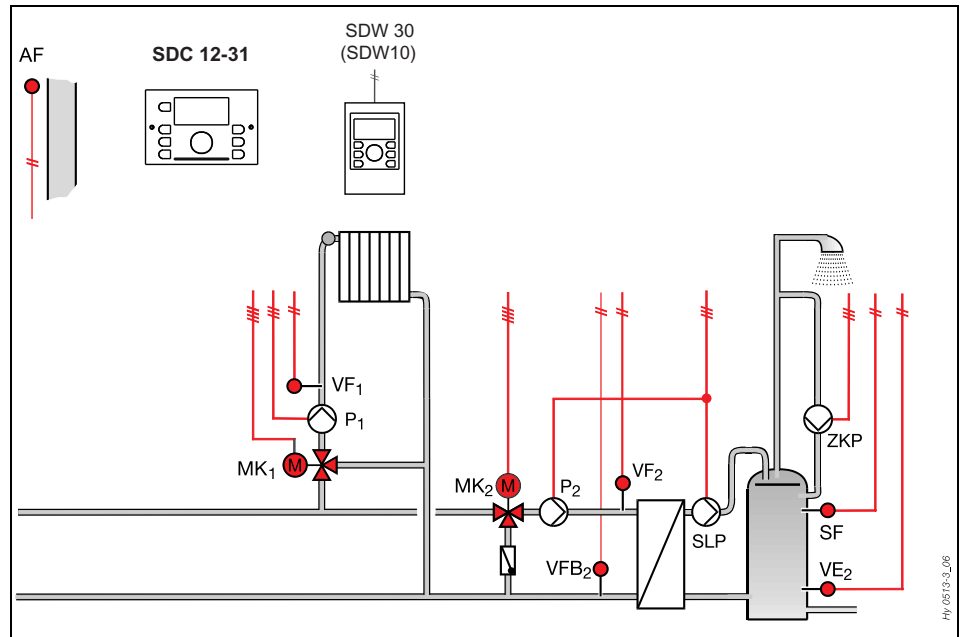

X 1		X 2		X 3		X 4	
23	GND	19		1		10	ZKP
24	BUS A	20		2		11	
25	BUS B	21	N	3		12	L 1
26	AF	22	L 1	4		13	MK2▲
27				5	SLP	14	MK2▼
28	SF			6	L 1	15	P2
29	VF 1			7	MK1▲	16	
30	VFB2			8	MK1▼	17	
31	VE2			9	P1	18	
32							
33	VF2						
34							
35							
36							
37							
38							

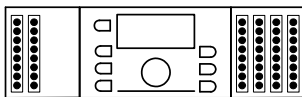

X 5		X 6		X 7		X 8		X 9		X 10	
1	Bus B	1	Bus A	1		1		1	N	1	PE
2	GND	2	AF	2		2		2	N	2	PE
3	GND	3		3		3	SLP	3	N	3	PE
4	GND	4	SF	4		4	MK1▲	4	N	4	PE
5	GND	5	VF 1	5	L 1	5	MK1▼	5	N	5	PE
6	GND	6	VFB2	6		6	P1	6	N	6	PE
7	GND	7	VE2	7		7	ZKP	7	N	7	PE
8	GND	8		8		8		8	N	8	PE
9	GND	9	VF2	9		9	MK2▲	9	N	9	PE
10	GND	10		10		10	MK2▼	10	N	10	PE
11	GND	11		11		11	P2	11	N	11	PE
12	GND	12						12	N	12	PE
								13	N	13	PE

### 11.15 Hydraulik 0514 (SDC 9-21, DHC-Modus) Hydraulics 0514 (SDC 9-21, DHC mode)

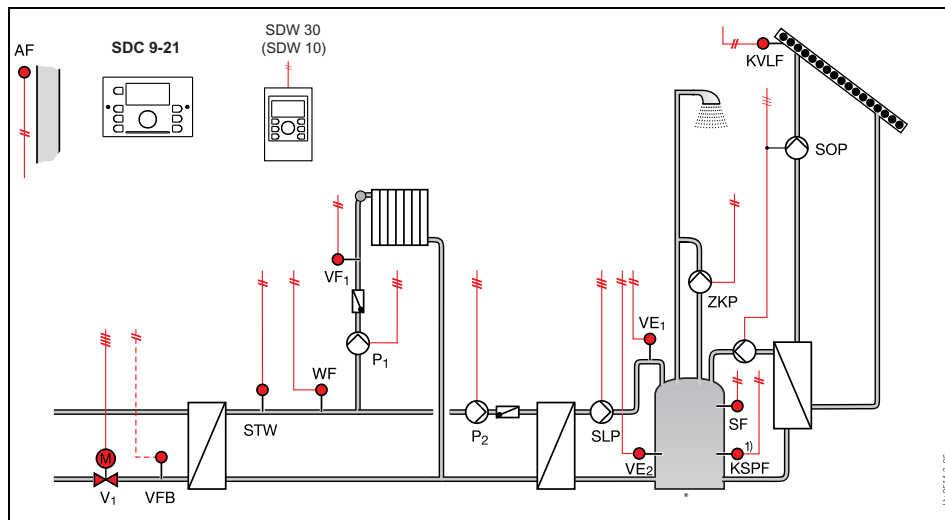

\* als Duofühler / as dual-sensor

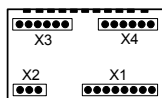

X 1		X 2		X 3		X 4	
23	GND	19		1	V 1 ▼	10	SLP
24	BUS A	20		2	L 1	11	ZKP
25	BUS B	21	N	3	SOP	12	L 1
26	AF	22	L 1	4		13	
27	WF			5	P2	14	
28	SF			6	L 1	15	
29	VF 1			7		16	V 1 ▲
30	VE1			8		17	
31	VE2			9	P1	18	L 1
32	VFB						
33							
34	KVLf						
35	KSPF						
36							
37							
38							

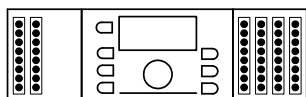

X 5		X 6		X 7		X 8		X 9		X 10	
1	Bus B	1	Bus A	1		1	V 1 ▼	1	N	1	PE
2	GND	2	AF	2		2	SOP	2	N	2	PE
3	GND	3	WF	3		3	P2	3	N	3	PE
4	GND	4	SF	4		4		4	N	4	PE
5	GND	5	VF 1	5	L 1	5		5	N	5	PE
6	GND	6	VE1	6		6	P1	6	N	6	PE
7	GND	7	VE2	7		7	SLP	7	N	7	PE
8	GND	8	VFB	8		8	ZKP	8	N	8	PE
9	GND	9		9		9		9	N	9	PE
10	GND	10	KVLf	10		10		10	N	10	PE
11	GND	11	KSPF	11	V 1 ▲	11		11	N	11	PE
12	GND	12						12	N	12	PE
								13	N	13	PE

**HINWEIS** Parametereingabe siehe 11.15.1 S. 87.

**NOTE** For parameter entry, see 11.15.1 pg. 87.

**11.15.1 Parametereingabe Hydraulik 0514 (SDC 9-21)**  
**Parameter entry of hydraulics 0514 (SDC 9-21)**

**Menü "Hydraulik" / "Hydraulics" menu**

<b>Parameter Parameter</b>	<b>Einstellwert Set value</b>	<b>Bemerkung</b>	<b>Remark</b>
01	0000	Keine Einstellung	No setting
02	1	Brauchwasserladepumpe	Process water charging pump
03	2	Direktheizkreispumpe	Direct heating circuit pump
04	–	Nicht vorhanden	Not available
05	15	Solarladepumpe	Solar charging pump
06	18	Schichtspeicherladepumpe (DHC)	Layered tank charging pump (DHC)
07	4	Zirkulationspumpe	Circulating pump
08	15	1. Schichtspeicherfühler (oben)	1. Layered tank sensor (top)
09	3	2. Schichtspeicherfühler (unten)	2. Layered tank sensor (bottom)
10	–	Nicht vorhanden, mit Begrenzungsfühler Fernheizung VFB belegt	Not present, occupied by limit sensor of district heating VFB
11	–	Nicht vorhanden	Not available

# Honeywell

---

Manufactured for and on behalf of the Environmental and Combustion Controls Division of Honeywell Technologies Sàrl, Rolle, Z.A. La Pièce 16, Switzerland by its Authorized Representative:

## **Automation and Control Solutions**

Honeywell GmbH  
Böblinger Strasse 17  
71101 Schönaich / Germany  
Phone (49) 7031 637 01  
Fax (49) 7031 637 493  
<http://ecc.emea.honeywell.com>

Gedruckt in Deutschland  
Alle Rechte und Änderungen vorbehalten.

MU1H-0207GE51 R0313  
Art. 045 130 5605 – 1311 – 32

## **Automation and Control Solutions**

Honeywell House  
Arlington Business Park  
Bracknell, Berks, RG12 1EB  
Phone (44) 1344 656000  
Fax (44) 1344 656644  
<http://honeywell.com/uk>

Printed in Germany  
All rights reserved. Subject to change  
without notice.